

jura®



JURA J80/J90/J95 Instructions for Use



For your safety: read and understand manual before use.

Your JURA J80/J90/J95

IMPORTANT SAFEGUARDS	4
Control elements	8
1 Preparing and using for the first time	10
JURA on the Internet.....	10
Setting up the machine	10
Filling the water tank.....	10
Filling the bean container.....	10
First-time use	11
Inserting and activating the filter.....	12
Determining and adjusting the water hardness.....	13
Connecting milk.....	15
2 Preparation	16
Ways of preparing a beverage	16
Espresso and coffee	17
Preparing two specialty coffees.....	17
Latte macchiato and Cappuccino.....	18
Warm milk and milk foam.....	18
Ground coffee	19
Permanently setting the amount of water for the cup size	20
Adjusting the grinder	20
Hot water.....	21
3 Daily operation	22
Switching on the machine.....	22
Daily maintenance	22
Regular maintenance	23
Switching off the machine.....	23
4 Permanent settings in programming mode	24
Product settings	25
Maintenance settings	26
Energy-saving mode	27
Automatic switch-off.....	28
Unit for amount of water.....	29
Restore factory settings	29
Language	30
Background color	31
Querying information	31

5	Maintenance	32
	Rinsing the machine.....	33
	Rinsing the cappuccino frother	33
	Cleaning the cappuccino frother.....	33
	Dismantling and rinsing the cappuccino frother	34
	Changing the filter.....	35
	Cleaning the machine	36
	Descaling the machine	38
	Cleaning the bean container.....	40
	Descaling the water tank.....	40
6	Display messages	41
7	Troubleshooting	42
8	Transport and environmentally friendly disposal	44
	Transport / Emptying the system.....	44
	Disposal.....	44
9	Technical data	45
10	Index	46
11	JURA contact details / Legal information	52

Symbol description

Warnings



This is the safety alert symbol. It is used to alert you to potential personal injury hazards. Obey all safety messages that follow this symbol to avoid possible injury or death.



DANGER indicates a hazardous situation which, if not avoided, will result in death or serious injury.



WARNING indicates a hazardous situation which, if not avoided, could result in death or serious injury.



CAUTION, used with the safety alert symbol, indicates a hazardous situation which, if not avoided, could result in minor or moderate injury.

NOTICE

NOTICE is used to address practices not related to personal injury.

Symbols used



Prompt to take action. This symbol means that you are being prompted to perform some action.



Information and tips to make it even easier to use your IMPRESSA.

'Coffee'

Display message

IMPORTANT SAFEGUARDS

Follow the basic safety precautions

When using electrical appliances, basic safety precautions shall always be followed, to reduce the risk of fire, electric shock, and/or injury to persons, including the following:

- Read all instructions.
- Do not touch hot surfaces. Use handles or knobs.
- To protect against fire, electric shock and injury to persons, do not immerse power cord, plugs, or body of machine in water or other liquid.
- Close supervision is necessary when any appliance is used by or near children.
- Unplug from outlet when not in use and before cleaning. Allow to cool before putting on or taking off parts, and before cleaning the appliance.
- Do not operate any appliance with a damaged cord or plug or after the appliance malfunctions, or has been damaged in any manner. Return appliance to the nearest authorized service facility for examination, repair or adjustment.
- The use of an accessory attachment not recommended by the appliance manufacturer may result in fire, electric shock, or injury to persons.
- Do not use outdoors.
- Do not let the cord hang over the edge of a table or counter, or touch hot surfaces.
- Do not place on or near a hot gas or electric burner, or in a heated oven.
- To disconnect, turn any control to 'OFF' then remove plug from wall outlet.
- Do not use appliance for other than intended use.
- Use extreme caution when dispensing hot steam, hot water or hot coffee.
- For household use only.

SAVE THESE INSTRUCTIONS.

Pass them on to any subsequent user.

Intended use The appliance is designed and intended for household use only. It shall only be used for coffee preparation and to heat milk and water, according to these instructions. Use for any other purpose will be deemed improper. JURA Elektroapparate AG cannot accept any responsibility for the consequences of improper use.

People, including children, who

- do not have the physical, sensory or mental capabilities to use the appliance safely or
- are inexperienced or lack knowledge in how to use the appliance safely

must be supervised by a responsible person when using it, or must be instructed in how to use it correctly.

Special power cord set instructions

- A short power-supply cord is to be provided to reduce risks resulting from becoming entangled in or tripping over a longer cord.
- The cord shall be arranged so that it will not drape over the counter top or table top where it can be pulled on by children or tripped over.
- This appliance has a 3-pin grounded plug.
- Do not modify the plug in any way.

Extension cords are available and may be used if care is exercised in their use.

If the user chooses to use an extension cord,

- the marked electrical rating of the extension cord should be at least as great as the electrical rating of the appliance, and
- if the appliance is of the grounded type, the extension cord should be a grounding type 3-wire cord, and
- the longer cord should be arranged so that it will not drape over the counter top or tabletop where it can be pulled on by children or tripped over.

 WARNING



To reduce the risk of fire or electric shock, DO NOT remove any service covers. DO NOT modify the appliance in any way that is not described in these instructions. NO user serviceable parts included. Repair MUST be done by authorized personnel only.

In the event of signs of damage, for example if there is a smell of burning, unplug the machine immediately from outlet and contact JURA customer service.

IMPORTANT SAFEGUARDS

CAUTION

This appliance is for household use. Any servicing other than cleaning and user maintenance shall be performed by an authorized service representative:

- Do not immerse base in water or try to disassemble.
- Do not put the appliance or any individual parts in the dishwasher.
- Check voltage to be sure that the voltage indicated on the name plate complies with your voltage. The name plate is located on the underside of the appliance.
- Never use warm or hot water to fill the water container. Use cold water only.
- Keep your hands and the cord away from hot parts of the appliance during operation.

There is a risk of scalds or burns on the spouts and the cappuccino frother / nozzle.

- Keep children away.
- Do not touch any hot parts. Use the handles or knobs provided.
- Ensure that the cappuccino frother / nozzle is correctly fitted and clean. If incorrectly fitted or if they become blocked, the cappuccino frother or its parts might come off.
- Never clean with scouring powders or hard implements.
- Ensure that the ventilation slots are not covered.
- Never pull out the drip tray during the brewing process. Only pull the drip tray when the display instructs you or when the appliance is ready for use.

NOTICE



NEVER DO
(or you will void your
warranty protection):

- Never fill instant coffee, chocolate mix etc. into the bean container or ground coffee funnel (filler funnel for ground coffee). It will damage the functioning of the brewing chamber.
- Never fill sugar coated coffee beans into the bean container. In case of doubt, call your dealer.
- Never fill anything other than coffee beans into the bean container (no chocolate, no rice, no nuts, no spices, nothing other than roasted coffee beans).
- Never fill frozen beans into the bean container. If you store beans in the freezer, let them thaw 3 to 4 hours before filling them into the bean container.
- Never fill anything but fresh, cold and clean water into the water tank, except when decalcifying.
- Never use mineral or carbonated water. You can use tap water, bottled water, spring water and reverse osmosis water.
- Never do anything with the machine which is not described in these instructions. In case of doubt, call your dealer.

Control elements

Control elements

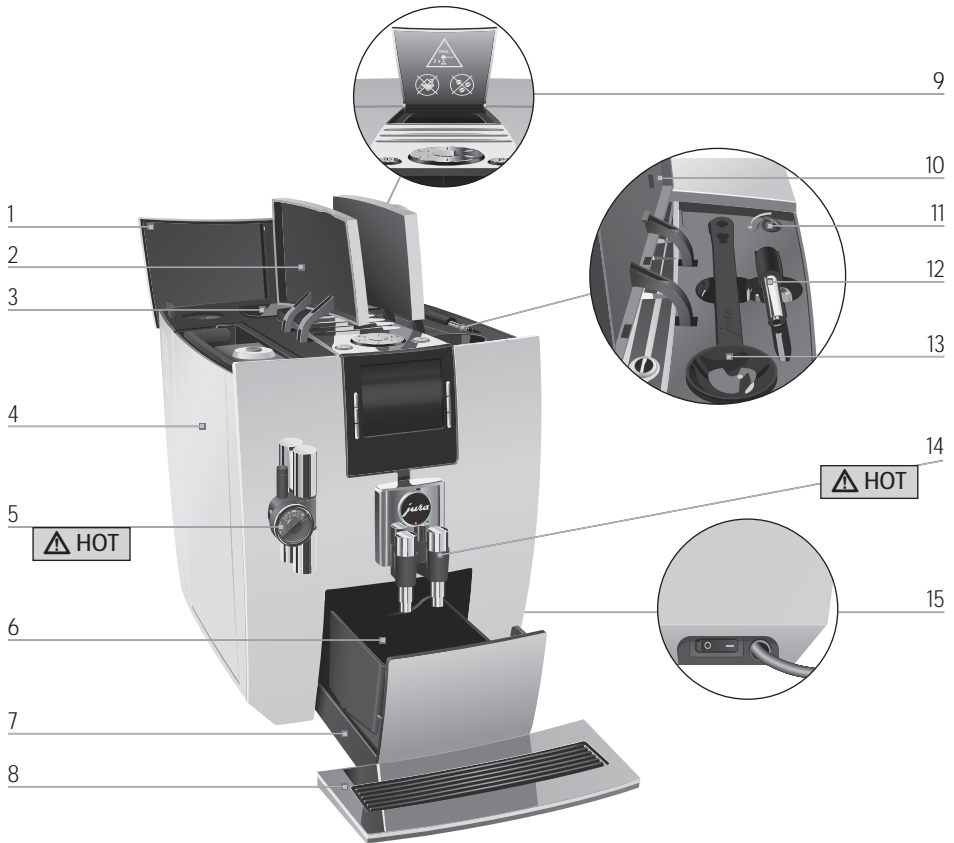

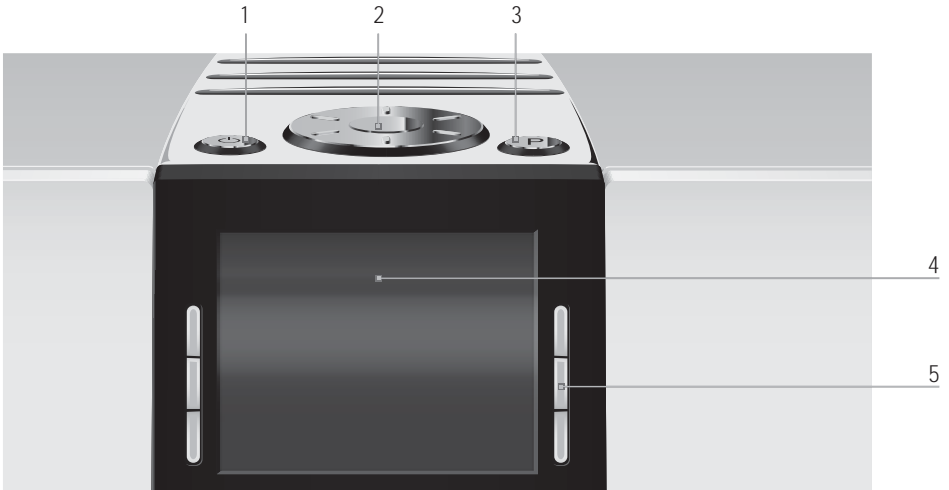

- | | | | |
|---|--|----|---|
| 1 | Bean container cover | 9 | Filler funnel for ground coffee |
| 2 | Water tank cover | 10 | Storage compartment cover |
| 3 | Bean container with aroma preservation cover | 11 | Grinder adjustment switch |
| 4 | Water tank | 12 | Hot-water nozzle* |
| 5 | Height-adjustable cappuccino frother | 13 | Measuring spoon for ground coffee |
| 6 | Coffee grounds container | 14 | Height- and width-adjustable coffee spout |
| 7 | Drip tray | 15 | Power switch and power cord (side of machine) |
| 8 | Cup platform | | |

*Not on all models



Top of the machine

- 1  On/Off button
- 2  Rotary Switch
- 3  P button (programming)

Front

- 4 Display
- 5 Buttons (button function depends on what is shown in the display)

1 Preparing and using for the first time

JURA on the Internet

Visit us on the Internet (www.jura.com). You will find interesting and up-to-date information on your JURA and on every aspect of coffee.

Setting up the machine

When setting up your JURA, please note the following:

- Place the JURA on a horizontal surface that is not sensitive to water.
- Choose a spot for your JURA which protects the machine against overheating. Ensure that the ventilation slots are not covered.



Filling the water tank

Daily maintenance of the machine and hygiene when handling milk, coffee and water are key to a perfect coffee result in the cup every time. You should therefore change the water **daily**.

NOTICE

Milk, sparkling mineral water or other liquids can damage the water tank or the machine.

- ▶ Only fill the water tank with fresh, cold water.
-
- ▶ Open the water tank cover.
 - ▶ Remove the water tank and rinse it with cold water.
 - ▶ Fill the water tank with fresh, cold water and reinsert the tank.
 - ▶ Close the water tank cover.



Filling the bean container

The bean container has an aroma preservation cover. This will ensure that your coffee beans retain their aroma for longer.

NOTICE

Coffee beans which have been treated with additives (e.g. sugar), ground coffee or freeze-dried coffee will damage the grinder.

- ▶ Only use roasted, untreated coffee beans to fill the bean container.

- ▶ Open the bean container cover and remove the aroma preservation cover.
- ▶ Remove any dirt or foreign objects from inside the bean container.
- ▶ Fill the bean container with coffee beans, then close the aroma preservation cover and the bean container cover.

First-time use



WARNING

If the machine is operated with a defective power cord, there is a danger of potentially fatal electric shock.

- ▶ Never use a machine which is damaged.
- ▶ Never use a machine which has a defective power cord.

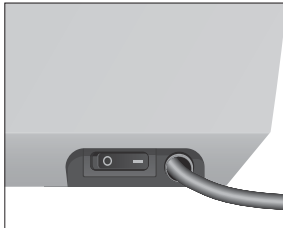
Precondition: The water tank and bean container have been filled.



- ▶ Insert the power plug into a power socket.
-  ▶ Switch on the JURA using the power switch on the right-hand side of the machine.
-  ▶ Press the On/Off button to switch the JURA on.
The display shows the languages you can choose from.

i To display more languages, press the **'Next'** button (bottom right).

- ▶ Press the button that corresponds to the language you want, e.g. **'English'**.

'Saved' appears briefly on the display to confirm the setting.
'Please press the Rotary Switch.', the Rotary Switch lights up.

- ▶ Place a receptacle under the cappuccino frother.

 ▶ Press the Rotary Switch.

'System is filling.', the system fills up with water. The operation stops automatically.

'Please press the Rotary Switch.'

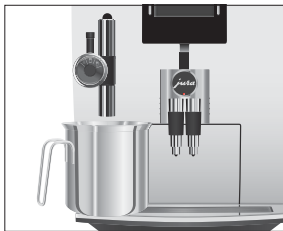

1 Preparing and using for the first time



- ▶ Place a receptacle under the coffee spout.
- ▶ Press the Rotary Switch.
'Machine is rinsing.', the machine rinses. The operation stops automatically. 'Please select product:' appears on the display. Your JURA is ready for use.
- ▶ **i** The display shows the products you can prepare.

Inserting and activating the filter

Your JURA no longer has to be descaled if you are using the CLEARYL Blue filter cartridge. If the water hardness is 10 °dH or more, we recommend using the filter cartridge.

- ▶ **i** If you do not know the hardness of your water, you must find this out first (see Chapter 1 'Preparing and using for the first time – Determining the water hardness').
- ▶ **i** Perform the 'inserting the filter' operation without any interruptions. This will ensure that your JURA always produces its best.

Precondition: 'Please select product:' is displayed.

- ▶ **P** Press the P button.
'Maintenance status (1/6)'
- ▶ Turn the Rotary Switch until the program item 'Maintenance settings (3/6)' is displayed.
- ▶ Press the 'Filter' button.
'Filter'
- ▶ Press the 'Active' button.
- ▶ Press the 'Save' button.
'Saved' appears briefly on the display.
'Insert filter'.
- ▶ Remove the filter cartridge extension from the Welcome Pack.
- ▶ Fit the filter extension on top of a CLEARYL Blue filter cartridge.
- ▶ Remove and empty the water tank.



- ▶ Open the filter holder and insert the filter cartridge into the water tank, exerting slight pressure.
- ▶ Close the filter holder. It will click into place audibly.

i After three months, the filter will cease to work. Set the date on the date plate on the filter holder in the water tank.

- ▶ Fill the water tank with fresh, cold water and reinsert the tank.
- ▶ Place a receptacle under the cappuccino frother.
- ▶ Press the 'Next' button.

'Filter is being rinsed.', water flows out of the cappuccino frother.

i You can interrupt rinsing of the filter at any time by pressing any button. Press the Rotary Switch  to continue rinsing of the filter.

i The water may be slightly discolored. This is not harmful to health and does not affect the taste.

Rinsing of the filter stops automatically after approximately 17 oz (500 ml). The JURA heats up and is once more ready for use. The filter is now activated.

Determining and adjusting the water hardness

i If you are using the CLEARYL Blue filter cartridge and have activated it in programming mode, you will not be able to adjust the water hardness.

The harder the water is, the more frequently the JURA needs to be descaled. It is therefore important to set the water hardness accurately.

The water hardness can be adjusted on a continuous scale between 1 °dH and 30 °dH.

Determining the water hardness

You can find out what the water hardness is by using the Aquadur® test strip supplied as standard.

- ▶ Hold the test strip briefly (for 1 second) under flowing water. Shake off the water.
- ▶ Wait for about one minute.

1 Preparing and using for the first time

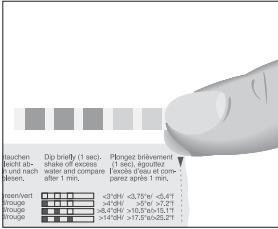

► You will then be able to read the degree of water hardness from the discoloration of the Aquadur® test strip and the description on the packaging.

You can now adjust the water hardness.

Level	Display German Degree (°dH)	Degrees of general hardness (°dGH)	Parts per million (ppm)	Indicator Strip number of 'reddish' fields
Not active	–	–	–	–
Very soft water	<3	<3	< 53.4	None
Soft water	> 4	> 4	> 71	1
Hard water	> 8.4	> 8.4	> 150	2
Very hard water	> 14	> 14	> 250	3

Setting the water hardness

Example: Proceed as follows to change the water hardness from '16 °dH' to '25 °dH'.

Precondition: 'Please select product:' is displayed.

- P ► Press the P button.
 - 'Maintenance status (1/6)'
- ⊙ ► Turn the Rotary Switch until the program item 'Maintenance settings (3/6)' is displayed.
 - Press the 'Water hardness' button.
 - 'Water hardness'
 - Press the '<' or '>' button to set the water hardness.
 - Press the 'Save' button.
 - 'Saved' appears briefly on the display to confirm the setting.
 - 'Maintenance settings (3/6)'
- P ► Press the P button to exit programming mode.
 - 'Please select product:'

Connecting milk

Your JURA creates fine, creamy, feather-light milk foam with a perfect consistency. The most important requirement for frothing milk is a milk temperature of 39–46 °F (4–8 °C). We would therefore recommend using a milk cooler or a vacuum milk container.

- ▶ Remove the protective cover from the cappuccino frother.

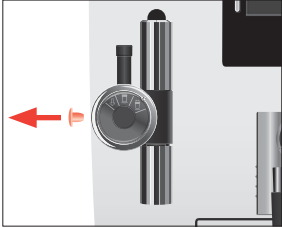

- ▶ Attach the milk pipe to the cappuccino frother.
- ▶ Connect the other end of the milk pipe to a milk container or immerse it in a milk carton.

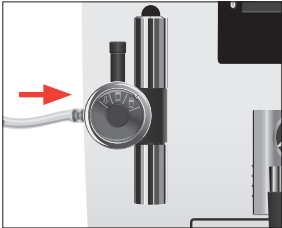







2 Preparation

⚠ WARNING

Hot coffee, hot steam and hot water can cause scalding. Scalding is a serious burn.

- ▶ Use extreme care when handling hot liquid or steam.
- ▶ Allow liquid to cool down before drinking.
- ▶ In the event of scalding, rinse affected area with cold water and seek medical attention.
- ▶ Keep children AWAY.

i While a specialty coffee or hot water is being prepared, you can stop preparation at any time. Just press any button.

i During the grinding operation you can select the **coffee strength** of single products by turning the Rotary Switch :  (extra-mild),  (mild),  (normal),  (strong) or  (extra-strong).

i During preparation, you can change the preset **amount of water** by turning the Rotary Switch  or pressing the '<' and '>' buttons.

i You can follow the current status of preparation on the display.

i The water volume is given as standard in 'oz'. You can change this setting to 'ml' in programming mode (see Chapter 4 'Permanent settings in programming mode – Unit for amount of water').

You can make permanent settings for all products in programming mode (see Chapter 4 'Permanent settings in programming mode – Product settings').

Ways of preparing a beverage

Only some of the specialty coffees you can prepare are shown on the display at any one time. As soon as you turn the Rotary Switch, more specialty coffees are displayed in the product selector view. The product selector view disappears automatically after 5 seconds if no preparation is started.

The following products are displayed as standard:

- 'Cappuccino'
- 'Latte macchiato'
- '1 portion milk'

- 'Espresso'
- 'Coffee'
- 'Hot water'

Additional specialty coffees in the product selector view:

- 'Ristretto'
- '2 ristretti'
- '2 espressi'
- '2 coffees'

Espresso and coffee

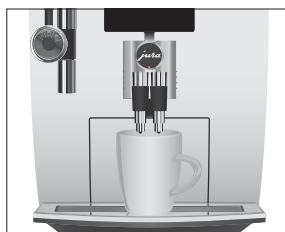

'Espresso' and 'Coffee' are prepared following this model.

Example: Proceed as follows to prepare one coffee.

- ▶ Place a cup under the coffee spout.
 - ▶ Press the 'Coffee' button.
- Preparation starts. The preset amount of water for coffee flows into the cup.
- Preparation stops automatically. 'Please select product:' appears on the display.

Preparing two specialty coffees



To prepare **two** specialty coffees, either use the product selector view or press the appropriate preparation button twice.

Example: Proceed as follows to prepare **two coffees** (using product selector view).

- ▶ Place two cups under the coffee spout.
 - ⊗ ▶ Turn the Rotary Switch to view the product selector.
 - ⊗ ▶ Turn the Rotary Switch until '2 coffees' is displayed.
 - ⊗ ▶ Press the Rotary Switch.
- Preparation starts. The preset amount of water for coffee flows into the cups.
- Preparation stops automatically. 'Please select product:' appears on the display.

- i** Proceed as follows to prepare two cups of coffee at the touch of a button: Place two cups under the coffee spout. Press the 'Coffee' button twice (**within two seconds**) to start coffee preparation.

Latte macchiato and Cappuccino



Your JURA can prepare a latte macchiato or cappuccino at the touch of a button. There is no need to move the glass or cup.

Example: Proceed as follows to prepare one latte macchiato.

Precondition: Milk is connected to the cappuccino frother.

- ▶ Place a glass under the cappuccino frother.
- ▶ Turn the setting wheel of the cappuccino frother to the Milk Foam position .
- ▶ Press the 'Latte macchiato' button.
'Latte macchiato', the milk foam is prepared.
Preparation stops automatically when the preset amount of milk is reached.

i There is a short interval while the hot milk separates from the milk foam. This allows the typical layers of a latte macchiato to form. You can choose the length of this interval in programming mode (see Chapter 4 'Permanent settings in programming mode – Product settings').

Coffee preparation starts. The preset amount of water for espresso flows into the glass. Preparation stops automatically. 'Please select product:' appears on the display.

To ensure that the cappuccino frother always works properly, you must clean it **daily** when you have been preparing milk (see Chapter 5 'Maintenance – Cleaning the cappuccino frother').

Warm milk and milk foam



Example: Proceed as follows to prepare milk foam.

Precondition: Milk is connected to the cappuccino frother.

- ▶ Place a cup under the cappuccino frother.
- ▶ Turn the setting wheel of the cappuccino frother to the Milk Foam position .

i If you want to **heat the milk** turn the setting wheel of the cappuccino frother to the Milk position .

- ▶ Press the '1 portion milk' button.
'1 portion milk'

As soon as the machine has heated up, 'Please select product:' appears.

- ▶ Press the '1 portion milk' button again.
'1 portion milk', the milk foam is prepared. Preparation stops automatically when the preset amount of milk is reached.
'Please select product:' appears on the display.

To ensure that the cappuccino frother always works properly, you must clean it **daily** when you have been preparing milk (see Chapter 5 'Maintenance – Cleaning the cappuccino frother').

Ground coffee

You can choose to use a second coffee variety, for example decaffeinated coffee, with the filter funnel for ground coffee.

- i** Never add more than two level measuring spoons of ground coffee.
- i** Use ground coffee which is not ground too finely. Very fine coffee can block up the system so that the coffee only comes out in drips.
- i** If you did not fill the machine with a sufficient amount of ground coffee, 'Not enough ground coffees' is displayed and the JURA stops the operation.
- i** The desired specialty coffee must be prepared within approximately one minute after filling with the ground coffee. Otherwise the JURA stops the operation and is once more ready for use.

All specialty coffees with ground coffee are always prepared following the same model.

Example: Proceed as follows to prepare one coffee using ground coffee.



- ▶ Place a cup under the coffee spout.
- ▶ Open the cover of the filler funnel for ground coffee.
'Please add ground coffee.'
- ▶ Place one level measuring spoon of ground coffee into the filler funnel.
- ▶ Close the cover of the filler funnel.
'Please select product:'
- ▶ Press the 'Espresso' button.
Preparation starts. The preset amount of water for coffee flows into the cup. Preparation stops automatically. 'Please select product:' appears on the display.

Permanently setting the amount of water for the cup size

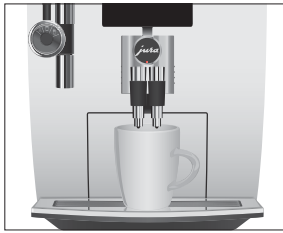

It is easy to permanently adjust the amount of water for all products to the cup size. Adjust the amount once as shown in the following example. Every time you prepare a drink in the future, this amount will be dispensed.

The permanent settings for adapting the amount of water to the cup size for all specialty coffees and hot water follow this model.

Example: Proceed as follows to **permanently** set the amount of water for one coffee.

Precondition: 'Please select product:' is displayed.

- ▶ Place a cup under the coffee spout.
- ▶ Press and **hold** the 'Coffee' button until 'Enough water? Press button' appears.
- ▶ Release the 'Coffee' button.
Preparation starts and the coffee flows into the cup.
- ▶ Press any button as soon as there is sufficient coffee in the cup.
Preparation stops. 'Saved' appears briefly on the display. The set amount of water for one coffee is permanently stored. 'Please select product:' appears on the display.

- i** You can alter this setting at any time by repeating the above procedure.
- i** The amount can be permanently adjusted to the cup size for the products shown in the product selector too. To do this, press and hold the Rotary Switch  until 'Enough water? Press button' appears.
- i** You can also permanently set the amount for all products in programming mode (see Chapter 4 'Permanent settings in programming mode – Product settings').

Adjusting the grinder

You can adjust the grinder on a continuous scale to suit the degree of roast of your coffee.

CAUTION

If you adjust the consistency of grind when the grinder is not operating, the grinder adjustment switch could be damaged.

- ▶ Only adjust the consistency of grind when the grinder is running.

The consistency of grind is correct if the coffee flows regularly from the coffee spout. In addition a fine, thick crema forms.

Example: Proceed as follows to change the consistency of grind **during** the preparation of an espresso.

- ▶ Open the storage compartment cover.
- ▶ Place a cup under the coffee spout.
- ▶ Press the 'Espresso' button.
The grinder starts up. 'Espresso' is displayed.
- ▶ Turn the grinder adjustment switch to the desired position **while** the grinder is running.
The espresso is prepared and the consistency of grind is adjusted.
- ▶ Close the storage compartment cover.



Hot water

The following temperatures can be selected for preparing hot water: 'Low', 'Normal', 'X high'.

- i** On some models you will find a separate hot-water nozzle under the cover of the storage compartment.

⚠ CAUTION

There is a danger of scalding from hot water splashes.

- ▶ Avoid direct contact with the skin.



- ▶ Place a cup under the cappuccino frother.
- ▶ Press the 'Hot water' button.
'Hot water' and the temperature are displayed.

- i** By pressing the '<' or '>' button several times (**within approximately 2 seconds**) you can set the temperature to your individual preference. This setting is not saved.

'Hot water', hot water flows into the cup.
Preparation stops automatically. 'Please select product:' appears on the display.



3 Daily operation

Switching on the machine

When the JURA is switched on, it automatically prompts you to perform the switch-on rinse. Start the switch-on rinse by pressing the Rotary Switch . In programming mode you can change this setting so that the machine starts the switch-on rinse automatically (see Chapter 4 'Permanent settings in programming mode – Maintenance settings').



Precondition: Your JURA is switched on at the power switch.

- ▶ Place a receptacle under the coffee spout.
-  ▶ Press the On/Off button to switch the JURA on.
'Welcome to JURA' appears on the display. The machine heats up.
'Please press the Rotary Switch.'
-  ▶ Press the Rotary Switch.
The machine rinses. The operation stops automatically.
'Please select product:' appears on the display.

Daily maintenance

To ensure that you get many years of reliable service out of your JURA and to guarantee the optimum coffee quality, the machine requires daily maintenance.

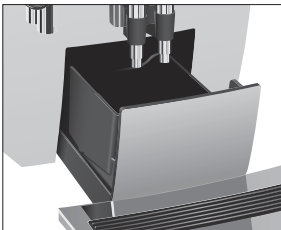

- ▶ Pull out the drip tray.
- ▶ Empty the coffee grounds container and the drip tray. Rinse them both with warm water.
- i** Always empty the coffee grounds container when the machine is **switched on**. This is the only way of resetting the coffee grounds counter.
 - ▶ Refit the coffee grounds container and the drip tray.
 - ▶ Rinse the water tank with clean water.
 - ▶ Remove the milk pipe and rinse it thoroughly under running water.
 - ▶ Dismantle and rinse the cappuccino frother (see Chapter 5 'Maintenance – Dismantling and rinsing the cappuccino frother').
 - ▶ Wipe the surface of the machine with a clean, soft, damp cloth (e.g. microfiber cloth).

Regular maintenance

Carry out the following maintenance actions **regularly** or **as required**:

- In the interests of hygiene, we recommend changing the milk pipe on a regular basis (approximately every 3 months). Replacement pipes are available from specialized dealers (JURA original accessory set for frothers).
- Clean the inside of the water tank, e.g. with a brush. Further information about the water tank is provided in these instructions for use (see Chapter 5 'Maintenance – Descaling the water tank').
- Traces of milk and coffee may stick to the top and bottom of the cup platform. If this happens, clean the cup platform.

Switching off the machine

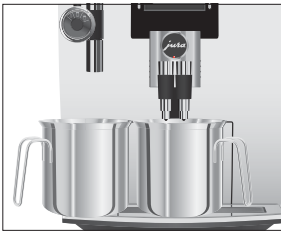

When you switch your JURA off, the spouts used to prepare a specialty coffee or milk are rinsed.

- ▶ Place one receptacle under the coffee spout and another under the cappuccino frother.
- ☰ ▶ Press the On/Off button.
 - ‘Machine is rinsing.’, ‘Milk system is being rinsed.’. The spouts used to prepare a specialty coffee or milk are rinsed. The operation stops automatically. Your JURA is switched off.

- i** When the JURA is switched off with the On/Off button, the machine consumes less than 0.1 W of standby energy. The machine can be completely disconnected from the power grid using the power switch.

4 Permanent settings in programming mode



WARNING

Hot coffee, hot steam and hot water can cause scalding. Scalding is a serious burn.

- ▶ Use extreme care when handling hot liquid or steam.
- ▶ Allow liquid to cool down before drinking.
- ▶ In the event of scalding, rinse affected area with cold water and seek medical attention.
- ▶ Keep children AWAY.

Press the P button to enter programming mode. You can navigate through the program items and permanently save the required settings simply by turning the Rotary Switch and using the multi-function buttons. The following settings can be made:

Programme item	Sub-item	Explanation
'Maintenance status (1/6)'	'Clean', 'Descale' (only if filter is not activated), 'Change the filter' (only if filter is activated), 'Switch-on rinse', 'Clean the milk system'	▶ Start the required maintenance program here.
'Product settings (2/6)'	'Expert mode'	▶ Select your settings for specialty coffees and hot water.
'Maintenance settings (3/6)'	'Filter', 'Water hardness' (only if filter is not activated), 'Switch-on rinse', 'Rinse the milk system'	▶ Indicate whether you are operating your JURA with or without a CLEARLY Blue filter cartridge. ▶ Adjust the water hardness. ▶ Change the settings for the switch-on rinse and milk system rinse.
'Machine settings 1 (4/6)'	'Save energy', 'Switch off after', 'Units', 'Factory setting'	▶ Select an energy-saving mode. ▶ Set the time after which the JURA should switch off automatically. ▶ Select the unit for the amount of water. ▶ Reset the permanently set values of all products to the factory settings.
'Machine settings 2 (5/6)'	'Choose language', 'Display', 'Colour scheme'	▶ Select your language and the background color for the display.

Programme item	Sub-item	Explanation
'Information (6/6)'	'Product counter', 'Maintenance counter', 'Version'	► Keep track of all specialty coffees prepared and view the number of maintenance programs performed.

Product settings



WARNING

Hot coffee, hot steam and hot water can cause scalding. Scalding is a serious burn.

- Use extreme care when handling hot liquid or steam.
- Allow liquid to cool down before drinking.
- In the event of scalding, rinse affected area with cold water and seek medical attention.
- Keep children AWAY.



In the programme item 'Product settings (2/6)' you can make individual settings for all specialty coffees and hot water. The following settings can be made:

Product	Temperature	Coffee strength	Amount
Ristretto, espresso, coffee	'Normal', 'High'	'extra-mild', 'mild', 'normal', 'strong', 'extra-strong'	Volume: '0.5 oz' – '8.0 oz' (25 ml – 240 ml)
Two ristretti, two espressi, two coffees	'Normal', 'High'	–	Volume: '0.5 oz' – '8.0 oz' (25 ml – 240 ml) (per cup)
Latte macchiato, cappuccino	'Normal', 'High'	'extra-mild', 'mild', 'normal', 'strong', 'extra-strong'	Amount of milk: '3 sec.' – '120 sec.' Interval: '0 sec.' – '60 sec.' Volume: '0.5 oz' – '8.0 oz' (25 ml – 240 ml)
Portion of milk	–	–	'3 sec.' – '120 sec.'
Hot water	'Low', 'Normal', 'X high'	–	'0.5 oz' – '15.0 oz' (25 ml – 450 ml)

Example: Proceed as follows to change the amount of milk for a latte macchiato from '16 sec.' to '20 sec.', the interval from '30 sec.' to '40 sec.' and the amount of water from '1.5 oz' (45 ml) to '1.0 oz' (40 ml).

Precondition: 'Please select product:' is displayed.

4 Permanent settings in programming mode

- P ▶ Press the P button.
‘Maintenance status (1/6)’
-  ▶ Turn the Rotary Switch until the program item ‘Product settings (2/6)’ is displayed.
 - ▶ Press the ‘Expert mode’ button.
‘Expert mode’
-  Next select the button of the product for which you would like to make settings. No product is prepared at this point.
 - ▶ Press the ‘Latte macchiato’ button.
‘Latte macchiato’
 - ▶ Press the ‘Amount of milk’ button.
 - ▶ Press the ‘<’ or ‘>’ button to change setting for the amount of milk to ‘20 sec.’.
 - ▶ Press the ‘Save’ button.
‘Saved’ appears briefly on the display.
 - ▶ Press the ‘Volume’ button.
 - ▶ Press the ‘<’ or ‘>’ button to change setting for the fill volume to ‘1.0 oz’ (40 ml).
 - ▶ Press the ‘Save’ button.
‘Saved’ appears briefly on the display.
 - ▶ Press the ‘Next’ button.
 - ▶ Press the ‘Interval’ button.
 - ▶ Press the ‘<’ or ‘>’ button to change setting for the interval to ‘40 sec.’.
 - ▶ Press the ‘Save’ button.
‘Saved’ appears briefly on the display.
‘Latte macchiato’
- P ▶ Press the P button to exit programming mode.
‘Please select product:’

Maintenance settings

In the program item ‘Maintenance settings (3/6)’ you can make the following settings:

- ‘Filter’
 - Activate the CLEARYL Blue filter cartridge (see Chapter 1 ‘Preparing and using for the first time – Inserting and activating the filter’).

- **'Water hardness'**
 - If you do not have a filter cartridge, you will need to set the water hardness (see Chapter 1 'Preparing and using for the first time – Setting the water hardness').
- **'Switch-on rinse' / 'Manual'**
 - The switch-on rinse must be started manually.
- **'Switch-on rinse' / 'Automatic'**
 - The switch-on rinse is started automatically.
- **'Rinse the milk system' / 'After 10 min.'**
 - You are prompted to rinse the milk system 10 minutes after preparation of a specialty coffee with milk.
- **'Rinse the milk system' / 'Immediate'**
 - You are prompted to rinse the milk system immediately after preparation of a specialty coffee with milk.

Example: Proceed as follows to make the machine prompt you to rinse the milk system **immediately** after preparing a specialty coffee with milk.

Precondition: 'Please select product:' is displayed.

- P ▶ Press the P button.
 - 'Maintenance status (1/6)'
-  ▶ Turn the Rotary Switch until the program item 'Maintenance settings (3/6)' is displayed.
 - ▶ Press the 'Rinse the milk system' button.
 - 'Rinse the milk system'
 - ▶ Press the 'Immediate' button.
 - ▶ Press the 'Save' button.
 - 'Saved' appears briefly on the display.
 - 'Maintenance settings (3/6)'
- P ▶ Press the P button to exit programming mode.
 - 'Please select product:'

Energy-saving mode

In the program item 'Machine settings 1 (4/6)' / 'Save energy' you can permanently set an energy-saving mode:

- **'Inactive'**
 - All specialty coffees, specialty coffees with milk and hot water can be prepared without having to wait.
 - The machine must heat up before milk preparation.

4 Permanent settings in programming mode

- **'Active'** (Energy saving of up to 40%)
 - Soon after the last preparation, the JURA stops heating up. As soon as the energy-saving temperature is reached, this is indicated in the display by the message **'Energy Save'** – this may take several minutes.
 - The machine must heat up before coffee, hot water or milk preparation.

Example: Proceed as follows to change the energy-saving mode from **'Inactive'** to **'Active'**.

Precondition: **'Please select product:'** is displayed.

- P** ▶ Press the P button.
'Maintenance status (1/6)'
-  ▶ Turn the Rotary Switch until the program item **'Machine settings 1 (4/6)'** is displayed.
 - ▶ Press the **'Save energy'** button.
'Save energy'
 - ▶ Press the **'Active'** button.
 - ▶ Press the **'Save'** button.
'Saved' appears briefly on the display.
'Machine settings 1 (4/6)'
- P** ▶ Press the P button to exit programming mode.
'Please select product:'

Automatic switch-off

By instructing your JURA to automatically switch itself off, you can cut down your energy consumption. If this function is activated, your JURA switches off automatically after the preset time following the last action on the machine.

You can set the automatic switch-off time to 15 minutes or 0.5–15 hours.

Precondition: **'Please select product:'** is displayed.

- P** ▶ Press the P button.
'Maintenance status (1/6)'
-  ▶ Turn the Rotary Switch until the program item **'Machine settings 1 (4/6)'** is displayed.
 - ▶ Press the **'Switch off after'** button.
'Switch off after'
 - ▶ Press the **'<'** or **'>'** button to change the setting.

- ▶ Press the 'Save' button.
- 'Saved' appears briefly on the display.
- 'Machine settings 1 (4/6)'
- P ▶ Press the P button to exit programming mode.
- 'Please select product:'

Unit for amount of water

You can change the unit for the amount of water from 'ml' to 'oz'.

Example: Proceed as follows to change the unit for the amount of water from 'oz' to 'ml'.

Precondition: 'Please select product:' is displayed.

- P ▶ Press the P button.
- 'Maintenance status (1/6)'
- ⊙ ▶ Turn the Rotary Switch until the program item 'Machine settings 1 (4/6)' is displayed.
- ▶ Press the 'Units' button.
- 'Units'
- ▶ Press the 'ml' button.
- ▶ Press the 'Save' button.
- 'Saved' appears briefly on the display.
- 'Machine settings 1 (4/6)'
- P ▶ Press the P button to exit programming mode.
- 'Please select product:'

Restore factory settings

In the program item 'Machine settings 1 (4/6)' / 'Factory setting' you can reset various settings to their factory settings:

- 'Machine'
 - All user settings (apart from the 'filter' and 'water hardness') are reset to factory settings. Your JURA then switches off.
- 'Products'
 - The settings (amount of water, aroma, temperature etc.) for any product can be reset **individually** to the factory settings. The corresponding double product is also reset to the factory settings at the same time.
- 'All products'
 - The settings (amount of water, aroma, temperature etc.) for **all products** are reset to the factory settings.
- 'Display'
 - All display settings are reset to the factory settings.

4 Permanent settings in programming mode

Example: Proceed as follows to reset the values for 'Espresso' to the factory settings.

Precondition: 'Please select product:' is displayed.

- P ▶ Press the P button.
'Maintenance status (1/6)'
-  ▶ Turn the Rotary Switch until the program item 'Machine settings 1 (4/6)' is displayed.
 - ▶ Press the 'Factory setting' button.
'Factory setting'
 - ▶ Press the 'Products' button.
 - ▶ Press the 'Espresso' button.
'Espresso' / 'Reset this product to the factory setting?'
 - ▶ Press the 'Next' button.
'Saved' appears briefly on the display.
'Factory setting'
- P ▶ Press the P button to exit programming mode.
'Please select product:'

Language

In this program item you can set the language used by your JURA.

- i** If you choose the wrong language by mistake, you can easily reset the machine to 'English': Press the P button to enter programming mode. Use the Rotary Switch  to select program item '5/6' and then press the top left-hand button.

Example: Proceed as follows to change the language from 'English' to 'Deutsch'.

Precondition: 'Please select product:' is displayed.

- P ▶ Press the P button.
'Maintenance status (1/6)'
-  ▶ Turn the Rotary Switch until the program item 'Machine settings 2 (5/6)' is displayed.
 - ▶ Press the 'Choose language' button.
'Choose language'
 - ▶ Press the 'Deutsch' button.
'Gespeichert' appears briefly on the display.
'Geräteeinstellungen 2 (5/6)'
- P ▶ Press the P button to exit programming mode.
'Bitte wählen Sie Ihr Produkt:'

Background color

In this program item you can set the background color for the display of your JURA.

Precondition: 'Please select product:' is displayed.

- P ▶ Press the P button.
'Maintenance status (1/6)'
 - ⊙ ▶ Turn the Rotary Switch until the program item 'Machine settings 2 (5/6)' is displayed.
 - ▶ Press the 'Colour scheme' button.
'Colour scheme'
 - ▶ Press the '<' or '>' button to change the setting.
 - ▶ Press the 'Save' button.
'Saved' appears briefly on the display.
'Machine settings 2 (5/6)'
 - P ▶ Press the P button to exit programming mode.
'Please select product:'
- i** The selected background color only applies on the selection page of the display showing the specialty coffees.

Querying information

In the program item 'Information (6/6)' you can view the following information:

- 'Product counter': Number of prepared specialty coffees, specialty coffees with milk and hot water
- 'Maintenance counter': Maintenance status and number of maintenance programs performed (cleaning, descaling, changing the filter)
- Number of cappuccino frother cleaning operations performed
- 'Version': Software version

Precondition: 'Please select product:' is displayed.

- P ▶ Press the P button.
'Maintenance status (1/6)'
- ⊙ ▶ Turn the Rotary Switch until the program item 'Information (6/6)' is displayed.
 - ▶ Press the 'Product counter' button.
The number of specialty coffees prepared is displayed.
 - ▶ Press the 'L' button.
'Information (6/6)'
- P ▶ Press the P button to exit programming mode.
'Please select product:'

5 Maintenance

⚠ WARNING

Use of maintenance products that are harmful to health and discharge of liquids during maintenance program. Harmful if swallowed. Irritating to eyes and skin.

- ▶ Keep children AWAY.
 - ▶ Keep children away from the machine while it is performing a maintenance program.
 - ▶ Avoid contact with skin and eyes.
 - ▶ Avoid generation of dust. Do not inhale dust.
 - ▶ When using do not eat or drink.
 - ▶ Keep maintenance products away from food, drink and animal food.
 - ▶ Keep container tightly closed and dry. Keep in a cool place.
-

Your JURA has the following integrated maintenance programs:

- Rinsing the machine ('Switch-on rinse')
- Rinsing the cappuccino frother ('Rinse the milk system')
- Cleaning the cappuccino frother ('Clean the milk system')
- Changing the filter ('Change the filter')
- Cleaning the machine ('Clean')
- Descaling the machine ('Descale')

i Clean or descale the machine, rinse the milk system or change the filter when you are prompted to do so.

i Press the P button to view a list of the maintenance programs ('Maintenance status (1/6)'). By referring to the bar you can see which maintenance program is due. When the bar is completely filled with red, your JURA will prompt you to perform the appropriate maintenance program.

i In the interests of hygiene, you should clean the milk system **daily** when you have been preparing milk.

Rinsing the machine

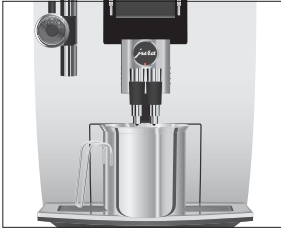

You can initiate the rinse operation manually at any time.

Precondition: 'Please select product:' is displayed.

- ▶ Place a receptacle under the coffee spout.
- P** ▶ Press the P button.
'Maintenance status (1/6)'
- ▶ Press the 'Switch-on rinse' button.
'Machine is rinsing.', water flows out of the coffee spout. The rinse stops automatically. 'Please select product:' appears on the display.

Rinsing the cappuccino frother

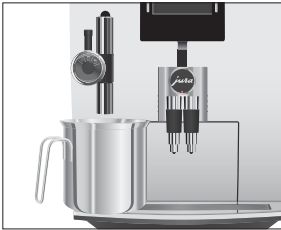

After each milk preparation, the JURA prompts you to perform a milk system rinse.

Precondition: 'Rinse the milk system' is displayed.

- ▶ Place a receptacle under the cappuccino frother.
-  ▶ Press the Rotary Switch.
'Milk system is being rinsed.', water flows out of the cappuccino frother.
The rinse stops automatically. 'Please select product:' appears on the display.

Cleaning the cappuccino frother

WARNING

To ensure that the cappuccino frother always works properly, you must clean it **daily** when you have been preparing milk.

Non-recommended cleaning agents will not optimally remove milk residues. This may cause the cappuccino frother to become blocked and fly off the machine. Discharge of hot steam.

- ▶ Use only original JURA milk system cleaner.

WARNING



Harmful and irritating cleaning agent. Harmful if swallowed.

Irritating to eyes and skin.

- ▶ Keep children AWAY.
- ▶ Avoid contact with skin and eyes.
- ▶ After contact with skin, wash immediately with plenty of water. In case of skin irritation, seek medical advice.
- ▶ After eye contact, immediately flush eyes with plenty of water and seek medical advice.
- ▶ If swallowed, rinse mouth immediately and drink large quantities of water. Do not induce vomiting. Seek medical advice immediately and show label.

i JURA milk system cleaner is available from specialized dealers.

Precondition: 'Please select product:' is displayed.

- P**
- ▶ Press the P button.
'Maintenance status (1/6)'
 - ▶ Press the 'Clean the milk system' button.
'Cleaning agent for milk system'
 - ▶ Pour 8.5 oz (250 ml) of fresh water into a receptacle and add one capful of milk system cleaner.
 - ▶ Immerse the milk pipe in the receptacle.
 - ▶ Turn the setting wheel of the cappuccino frother to the Milk Foam  or Milk  position.
 - ▶ Place another receptacle under the cappuccino frother.
 - ▶ Press the 'Next' button.
'Milk system is being cleaned.', water flows out of the cappuccino frother.
'Water for cleaning milk system'
 - ▶ Rinse the receptacle thoroughly, fill it with 8.5 oz (250 ml) of fresh water and immerse the milk pipe in the water.
 - ▶ Empty the other receptacle and place it under the cappuccino frother again.
 - ▶ Press the 'Next' button.
'Milk system is being cleaned.', the cappuccino frother and the pipe are rinsed with fresh water.
'Please select product:' appears on the display.



Dismantling and rinsing the cappuccino frother

To make sure the cappuccino frother works properly, and in the interests of hygiene, it must be dismantled and rinsed **daily** if you have been preparing milk.

- ▶ Remove the milk pipe and rinse it thoroughly under running water.
- ▶ Carefully pull the cappuccino frother down and off.
- ▶ Dismantle the cappuccino frother into its individual parts.
- ▶ Rinse all the parts under running water. If there are severely dried-on milk residues, firstly immerse the individual parts in a solution of 8.5 oz (250 ml) cold water and one capful of JURA milk system cleaner. Then rinse the parts thoroughly.
- ▶ Reassemble the cappuccino frother.

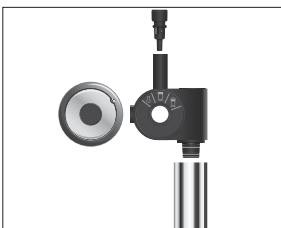

Changing the filter

- i** Ensure that all individual parts are correctly and firmly connected to ensure correct operation of the cappuccino frother.
 - ▶ Firmly attach the frother to the connector.

- i** After 2000 oz (60 liters) of water have flowed through, the filter will cease to work. Your JURA will automatically prompt you to change the filter.
- i** After three months, the filter will cease to work. Set the date on the date plate on the filter holder in the water tank.
- i** If the CLEARYL Blue filter cartridge is not activated in programming mode, you will not be prompted to change the filter.

Precondition: 'Change filter' is displayed.

- P**
 - ▶ Press the P button.
 - 'Maintenance status (1/6)'
 - ▶ Press the 'Change the filter' button.
 - 'Change the filter'
- i** If you do not want to start changing the filter just yet, press the 'L' button. The prompt 'Change filter' remains active.
 - ▶ Press the 'Next' button.
 - 'Change filter'
 - ▶ Remove and empty the water tank.
 - ▶ Open the filter holder and remove the old CLEARYL Blue filter cartridge and filter extension.
 - ▶ Fit the filter extension on top of a **new** filter cartridge.
 - ▶ Insert the filter cartridge into the water tank, exerting slight pressure.
 - ▶ Close the filter holder. It will click into place audibly.
 - ▶ Fill the water tank with fresh, cold water and reinsert the tank.



5 Maintenance

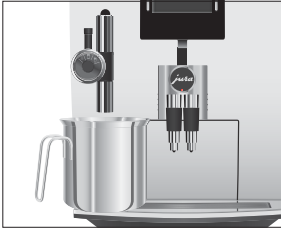

- ▶ Place a receptacle (at least 17 oz or 500 ml) under the cappuccino frother.
- ▶ Turn the setting wheel of the cappuccino frother to the Steam ⬇ position.
- ▶ Press the 'Next' button.
'Filter is being rinsed.', water flows out of the cappuccino frother.

i You can interrupt rinsing of the filter at any time by pressing any button. Press the Rotary Switch  to continue rinsing of the filter.

i The water may be slightly discolored. This is not harmful to health and does not affect the taste.

Rinsing of the filter stops automatically after approximately 17 oz (500 ml). The JURA heats up and is once more ready for use.

Cleaning the machine

After 200 preparations or 80 switch-on rinses, the JURA will prompt you to clean it.

WARNING

Non-recommended (e.g. liquid) cleaning agents may contain substances that could damage the machine or leave residues.

- ▶ Use only original JURA cleaning tablets. These are specially formulated for your machine.

WARNING

Harmful and irritating cleaning agent. Harmful if swallowed. Irritating to eyes and skin.

- ▶ Keep children AWAY.
- ▶ Avoid contact with skin and eyes.
- ▶ Avoid generation of dust. Do not inhale dust.
- ▶ After contact with skin, wash immediately with plenty of water. In case of skin irritation, seek medical advice.
- ▶ After eye contact, immediately flush eyes with plenty of water and seek medical advice.
- ▶ If swallowed, rinse mouth immediately and drink large quantities of water. Do not induce vomiting. Seek medical advice immediately and show label.

- i** The cleaning program lasts approximately 20 minutes.
- i** Do not interrupt the cleaning program. The quality of cleaning will be impaired if you do so.
- i** JURA cleaning tablets are available from specialized dealers.

Precondition: 'Clean machine' is displayed.

- P**
- ▶ Press the P button.
 - 'Maintenance status (1/6)'
 - ▶ Press the 'Clean' button.
 - 'Clean'

- i** If you do not want to start cleaning just yet, press the 'L' button. The prompt 'Clean machine' remains active.

- ▶ Press the 'Next' button.
- 'Empty coffee grounds container'
- ▶ Empty the drip tray and coffee grounds container and put them back into the machine.
- 'Please press the Rotary Switch.'



- ▶ Place one receptacle under the coffee spout and another under the cappuccino frother.
- ▶ Press the Rotary Switch.
- 'Machine is being cleaned.', water flows out of the coffee spout.

The operation is interrupted, 'Add cleaning tablet'.

- ▶ Open the cover of the filler funnel for ground coffee.
- ▶ Insert a JURA cleaning tablet into the filler funnel.
- ▶ Close the cover of the filler funnel.

'Please press the Rotary Switch.'



- ▶ Press the Rotary Switch.
- 'Machine is being cleaned.', water flows repeatedly out of the coffee spout and the cappuccino frother.

The operation is interrupted, 'Empty coffee grounds container'.

- ▶ Empty the drip tray and coffee grounds container and put them back into the machine.

Cleaning is now complete. Your JURA is once more ready for use.



Descaling the machine

The JURA builds up deposits of limescale over time and automatically prompts you to descale it when necessary. The degree of calcification depends on the hardness of your water.

⚠ WARNING

Non-recommended descaling agents (e.g. vinegar) may contain substances that could damage the machine or leave residues.

- ▶ Use only original JURA descaling tablets. These are specially formulated for your machine.

⚠ WARNING

Harmful and irritating descaling agent. Harmful if swallowed. Irritating to eyes and skin.

- ▶ Keep children AWAY.
- ▶ Avoid contact with skin and eyes.
- ▶ Avoid generation of dust. Do not inhale dust.
- ▶ After contact with skin, wash immediately with plenty of water. In case of skin irritation, seek medical advice.
- ▶ After eye contact, immediately flush eyes with plenty of water. Remove contact lenses. Seek medical advice.
- ▶ If swallowed, rinse mouth immediately and drink large quantities of water. Do not induce vomiting. Seek medical advice immediately and show label.

NOTICE

If the descaling operation is interrupted, there may be damage to the machine.

- ▶ Allow the descaling program to run to the end.

- i** The descaling program lasts approximately 50 minutes.
- i** JURA descaling tablets are available from specialized dealers.
- i** If you use a CLEARYL Blue filter cartridge and this is activated, you will not be prompted to descale.
- i** If the descaling agent comes into contact with sensitive surfaces (e.g. marble), damage cannot be ruled out. Clean up any splashes immediately.

Precondition: 'Decalcify machine' is displayed.

- P**
- ▶ Press the P button.
'Maintenance status (1/6)'
 - ▶ Press the 'Descal' button.
'Descal'

- i** If you do not want to start descaling just yet, press the 't' button. The prompt 'Decalcify machine' remains active.

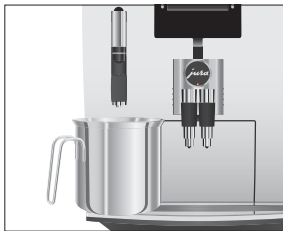
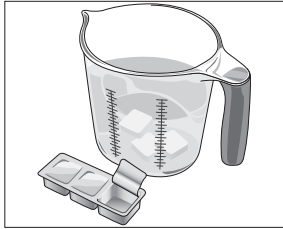

- ▶ Press the 'Next' button.
'Empty drip tray'
- ▶ Empty the drip tray and coffee grounds container and put them back into the machine.
'Pour descaling agent into water tank'.
- ▶ Remove and empty the water tank.
- ▶ Completely dissolve 3 JURA descaling tablets in a receptacle holding 17 oz (500 ml) of water. This may take several minutes.
- ▶ Pour the solution into the empty water tank and insert it into the machine.
'Please press the Rotary Switch.'
- ▶ Carefully pull the cappuccino frother down and off.
- ▶ Place a receptacle under the connector of the cappuccino frother.
- ▶ Press the Rotary Switch.
'Machine is being descaled.', water flows repeatedly out of the connector of the cappuccino frother.
The operation stops automatically, 'Empty drip tray'.
- ▶ Empty the receptacle under the connector of the cappuccino frother.
- ▶ Empty the drip tray and coffee grounds container and put them back into the machine.
'Fill water tank'
- ▶ Remove the water tank and rinse it thoroughly.
- ▶ Fill the water tank with fresh, cold water and reinsert the tank.
'Please press the Rotary Switch.'
- ▶ Refit the cappuccino frother.
- ▶ Place one receptacle under the coffee spout and another under the cappuccino frother.
- ▶ Press the Rotary Switch.
'Machine is being descaled.', water flows out of the cappuccino frother and the coffee spout.
'Machine is heating.', 'Machine is rinsing.', water flows out of the coffee spout.
The operation stops automatically, 'Empty drip tray'.



- ▶ Empty the drip tray and coffee grounds container and put them back into the machine.
Descaling is now complete. Your JURA is once more ready for use.

i If the descaling operation stops unexpectedly, rinse the water tank thoroughly.

Cleaning the bean container

Coffee beans may be covered with a slight oil film which remains on the walls of the bean container. These traces may negatively affect the coffee result. For this reason clean the bean container from time to time.

Precondition: 'Fill bean container' is displayed.

-  ▶ Switch the machine off with the On/Off button.
-  ▶ Switch the machine off at the power switch.
- ▶ Open the bean container cover and remove the aroma preservation cover.
- ▶ Clean the bean container with a soft, dry cloth.
- ▶ Fill the bean container with coffee beans, then close the aroma preservation cover and the bean container cover.

Descaling the water tank

Limescale deposits may form in the water tank. To ensure correct function of the machine, descale the water tank from time to time.

- ▶ Remove the water tank.
- ▶ If you use a CLEARLYL Blue filter cartridge, remove this.
- ▶ Completely fill the water tank and dissolve 3 JURA descaling tablets in it.
- ▶ Leave the water tank with the descaling solution for several hours (e.g. overnight).
- ▶ Empty the water tank and rinse it thoroughly.
- ▶ If you use a CLEARLYL Blue filter cartridge, insert this again.
- ▶ Fill the water tank with fresh, cold water and reinsert the tank.

6 Display messages

Message	Cause/Result	Action
'Fill water tank'	The water tank is empty. You cannot prepare any products.	▶ Fill the water tank (see Chapter 1 'Preparing and using for the first time – Filling the water tank').
'Empty coffee grounds container'	The coffee grounds container is full. You cannot prepare any products.	▶ Empty the coffee grounds container and the drip tray (see Chapter 3 'Daily operation – Daily maintenance').
'Empty drip tray'	The drip tray is full. You cannot prepare any products.	▶ Empty the drip tray. ▶ Clean and dry the metal contacts on the back of the drip tray.
'Drip tray not fitted'	The drip tray is not inserted correctly or is not inserted at all. You cannot prepare any products.	▶ Fit the drip tray.
'Please press the Rotary Switch.'	The JURA is prompting you to perform a rinse or continue a maintenance program that was already started.	▶ Press the Rotary Switch to start the rinse or to continue the maintenance program.
'Fill bean container'	The bean container is empty. You cannot prepare any products.	▶ Fill the bean container (see Chapter 1 'Preparing and using for the first time – Filling the bean container').
'Rinse the milk system'	The JURA requests a milk system rinse.	▶ Press the Rotary Switch to start rinsing the milk system.
'Change filter'	The filter cartridge no longer works.	▶ Replace the CLEARYL Blue filter cartridge (see Chapter 5 'Maintenance – Changing the filter').
'Clean machine'	The JURA is prompting you to clean it.	▶ Perform cleaning (see Chapter 5 'Maintenance – Cleaning the machine').
'Decalcify machine'	The JURA is prompting you to descale it.	▶ Perform descaling (see Chapter 5 'Maintenance – Descaling the machine').
'Not enough ground coffee'	There is insufficient ground coffee in the machine; the JURA stops the operation.	▶ The next time you prepare a beverage, add more ground coffee (see Chapter 2 'Preparation – Ground coffee').

7 Troubleshooting

Problem	Cause/Result	Action
When preparing a latte macchiato, the typical three layers do not form.	–	<ul style="list-style-type: none"> ▶ Turn the setting wheel of the cappuccino frother to the far right and the Milk Foam position . ▶ Change the length of the interval to at least 30 seconds in programming mode (see Chapter 4 ‘Permanent settings in programming mode – Product settings’).
Insufficient foam is produced when the milk is frothed or milk sprays from the cappuccino frother.	The cappuccino frother is dirty.	<ul style="list-style-type: none"> ▶ Clean the cappuccino frother (see Chapter 5 ‘Maintenance – Cleaning the cappuccino frother’). ▶ Check that the air intake pipe is fitted on the cappuccino frother. ▶ Rinse or replace the air intake pipe. You will find a replacement in the Welcome Pack.
Coffee only comes out in drips when it is being prepared.	Coffee or ground coffee has been ground too finely and is blocking the system. The same filter cartridge may have been used several times or the water hardness set incorrectly in the programming mode.	<ul style="list-style-type: none"> ▶ Put the grinder on a coarser setting or use coarser ground coffee (see Chapter 2 ‘Preparation – Adjusting the grinder’). ▶ Perform descaling (see Chapter 5 ‘Maintenance – Descaling the machine’).
Water hardness cannot be adjusted.	The CLEARYL Blue filter cartridge is activated.	<ul style="list-style-type: none"> ▶ Deactivate the filter cartridge in programming mode.
‘Fill bean container’ is not displayed although the bean container is empty.	The bean monitor is dirty.	<ul style="list-style-type: none"> ▶ Clean the bean container (see Chapter 5 ‘Maintenance – Cleaning the bean container’).
‘Empty drip tray’ is always displayed.	The metal contacts of the drip tray are dirty or wet.	<ul style="list-style-type: none"> ▶ Clean and dry the metal contacts on the back of the drip tray.

Problem	Cause/Result	Action
'Fill water tank' is displayed although the water tank is full.	The water tank float is trapped.	<ul style="list-style-type: none"> ▶ Descale the water tank (see Chapter 5 'Maintenance – Descaling the water tank').
Little or no water or steam comes out of the cappuccino frother. The pump is very quiet.	The connector of the cappuccino frother may be blocked by milk residues or limescale fragments loosened during descaling.	<ul style="list-style-type: none"> ▶ Remove the cappuccino frother. ▶ Unscrew the black connector with the aid of the hexagonal hole on the measuring spoon for ground coffee. ▶ Clean the connector thoroughly. ▶ Screw the connector back on by hand. ▶ Carefully tighten it using the hexagonal hole on the measuring spoon, turning by no more than a quarter of a rotation.
Grinder is making a very loud noise.	There are foreign objects in the grinder.	<ul style="list-style-type: none"> ▶ Contact customer support in your country (see Chapter 11 'JURA contact details / Legal information').
'ERROR 2' is displayed.	If the machine was exposed to the cold for a long period of time, heating is disabled for safety reasons.	<ul style="list-style-type: none"> ▶ Warm the machine at room temperature.
Other 'ERROR' messages are displayed.	–	<ul style="list-style-type: none"> ▶ Switch the JURA off at the power switch. Contact customer support in your country (see Chapter 11 'JURA contact details / Legal information').

i If you were unable to solve the problem, contact customer support in your country (see Chapter 11 'JURA contact details / Legal information').

8 Transport and environmentally friendly disposal

Transport / Emptying the system



In order to protect the JURA from frost during transport, the system must be emptied.

Precondition: 'Please select product:' is displayed.

- ▶ Carefully pull the cappuccino frother down and off.
- ▶ Place a receptacle under the connector of the cappuccino frother.
- ▶ Press the '1 portion milk' button.

'Machine is heating.'

As soon as the machine has heated up, 'Please select product:' appears.

- ▶ Press the '1 portion milk' button again.
'1 portion milk', hot steam is discharged from the connector.
- ▶ Remove and empty the water tank.
- ▶ Turn the Rotary Switch until '60 sec.' is displayed.
Steam will continue to be discharged from the connector until the system is empty.
'Fill water tank'
- ▶ Press the On/Off button.
The JURA is switched off.

Disposal

Please dispose of old machines in an environmentally neutral way.



9 Technical data

Voltage	120 V ~, 60 Hz
Power	1450 W
Conformity mark	
Energy consumption 'Save energy' / 'Active'	Approx. 5 Wh
Energy consumption 'Save energy' / 'Inactive'	approx. 12 Wh
Pump pressure	static, max. 15 bar
Holding capacity of water tank	71 oz (2.1 l)
Holding capacity of bean container	8.8 oz (250 g)
Holding capacity of coffee grounds container	max. 16 portions
Cable length	approx. 47 in. (approx. 1.2 m)
Weight	approx. 24 lb (approx. 10.9 kg)
Dimensions (W × H × D)	11.2 × 13.5 × 17 in. (28.5 × 34.2 × 43.3 cm)

Directives The machine complies with the following directives:

- Standard UL 1082
- Canadian Standard CSA C22.2 No. 64

10 Index

A

- Addresses 52
- Aroma preservation cover
 - Bean container with aroma preservation cover 8
- Automatic switch-off 28

B

- Background color 31
- Bean container
 - Bean container with aroma preservation cover 8
 - Cleaning 40
 - Filling 10
- Bus bar
 - Technical data 45
- Button
 - On/Off button 9
 - P button (programming) 9

C

- Cappuccino 18
- Cappuccino frother
 - Cleaning 33
 - Dismantling and rinsing 34
 - Rinsing 33
- Cleaning
 - Bean container 40
 - Cappuccino frother 33
 - Machine 36
- CLEARYL Blue filter cartridge
 - Changing 35
 - Inserting and activating the filter 12
- Coffee 17
- Coffee grounds container 8
- Coffee spout
 - Height- and width-adjustable coffee spout 8
- Consistency of grind
 - Adjusting the grinder 20
 - Grinder adjustment switch 8
- Contact details 52
- Cover
 - Bean container 8
 - Storage compartment 8
 - Water tank 8

- Cup platform 8
- Customer support 52

D

- Degree of water hardness 13
- Descaling
 - Machine 38
 - Water tank 40
- Determining and adjusting the water hardness 13
- Dismantling
 - Cappuccino frother 34
- Display 9
- Display messages 41
- Display settings 31
- Disposal 44
- Double product 17
- Drip tray 8

E

- Emptying the system 44
- Energy-saving mode 27
- Errors
 - Troubleshooting 42
- Espresso 17

F

- Factory settings
 - Restore factory settings 29
- Filler funnel
 - Filler funnel for ground coffee 8
- Filling
 - Bean container 10
 - Water tank 10
- Filter
 - Changing 35
 - Inserting and activating the filter 12
- First-time use 11
- Frother
 - Cappuccino frother 8

G

- Grinder adjustment switch 8
- Ground coffee 19
 - Measuring spoon for ground coffee 8

H

- Hotline 52
- Hot water 21
- Hot-water nozzle 8

I

- Important safeguards
 - Safety 4
- Instant coffee
 - Ground coffee 19
- Internet 10

J

- JURA
 - Contact details 52
 - Internet 10

L

- Language 30
- Latte macchiato 18

M

- Machine
 - Cleaning 36
 - Descaling 38
 - Regular maintenance 23
 - Rinsing 33
 - Setting up 10
 - Switching off 23
 - Switching on 22
- Maintenance 32
 - Daily maintenance 22
 - Regular maintenance 33
- Maintenance settings 26
- Measuring spoon for ground coffee 8
- Messages, display 41
- Milk
 - Connecting milk 15
- Milk foam 18
- Milk system cleaning
 - Cleaning the cappuccino frother 33
- Milk system rinsing
 - Rinsing the cappuccino frother 33
- Milk, warm 18

P

- Permanently setting the water for the cup
 - size 20
- Permanent settings in programming mode 24
- Power cord 8
- Power switch 8
- Preparation 16
 - Cappuccino 18
 - Coffee 17
 - Espresso 17
 - Ground coffee 19
 - Hot water 21
 - Latte macchiato 18
 - Milk 18
 - Two specialty coffees 17
- Problems
 - Troubleshooting 42
- Product settings 25
- Programming mode 24
 - Automatic switch-off 28
 - Background color 31
 - Energy-saving mode 27
 - Language 30
 - Maintenance settings 26
 - Product settings 25
 - Querying information 31
 - Restore factory settings 29
 - Setting the water hardness 14
 - Unit for amount of water 29

Q

- Querying information 31

R

- Regular maintenance 23
- Rinsing
 - Cappuccino frother 33
 - Machine 33
- Rotary Switch 9

S

- Safety
 - Important safeguards 4
- Settings
 - Maintenance settings 26
 - Permanent settings in programming mode 24
- Setting up
 - Setting up the machine 10
- Short operating instructions 10
- Switching off 23
- Switching on 22
- Switch-off
 - Automatic switch-off 28
- Symbol description 3

T

- Technical data 45
- Tel 52
- Transport 44
- Troubleshooting 42
- Two products 17

U

- Unit for amount of water 29
- Use, First-time 11

W

- Warm milk 18
- Water hardness
 - Determining the water hardness 13
 - Setting the water hardness 14
- Water tank 8
 - Descaling 40
 - Filling 10
- Website 10

- intentionally blank -

– intentionally blank –

- intentionally blank -

11 JURA contact details / Legal information

11 JURA contact details / Legal information

JURA Elektroapparate AG
 Kaffeeweltstrasse 10
 CH-4626 Niederbuchsiten
 Switzerland

	USA: JURA Inc.	Canada: FAEMA
Customer Service		
Phone	1-800-220-5701	1-(855)-544-8600
E-Mail	info@us.jura.com	info@juracanada.ca
Opening Hours (EST)	Mon – Thu 9am – 9pm Fri 9am – 8pm Sat 9am – 5pm	
Distributor Address	20 Craig Road Montvale, NJ 07645	115 Matheson Boulevard East Mississauga, Ontario, L4Z 1X8
Phone	001 (201) 767-3999	1-(905)-501-8600
Fax	001 (201) 767-9684	
Internet	www.us.jura.com	www.ca.jura.com

@ You will find additional contact details for your country at www.jura.com.

Technical changes We reserve the right to make technical changes. The diagrams used in these instructions for use are for illustration purposes only and do not represent the original colors of the machine. Some details of your JURA may vary.

Feedback Your opinion is important to us! Use the contact details at www.jura.com.

Copyright The instructions for use contain information which is protected by copyright. It is not permitted to photocopy these instructions for use or translate them into another language without the prior written consent of JURA Elektroapparate AG.