

jura®



en

fr

es

pt

Instructions for use for ENA Micro 5



For your safety: read and understand manual before use.

Your ENA Micro 5

IMPORTANT SAFEGUARDS	4
Control elements	8
1 Preparing and using for the first time	10
Setting up the machine.....	10
Filling the bean container	10
First-time use.....	10
First-time use with filter cartridge activation	10
First-time use without filter cartridge activation	11
Filling the water tank	12
Determining the water hardness	12
2 Preparation	12
Rotating coffee spout	13
Ristretto, espresso and coffee	13
Permanently setting the amount of water for the cup size.....	13
Adjusting the grinder.....	14
Ground coffee.....	14
3 Daily operation	15
Switching on the machine	15
Daily maintenance.....	15
Switching off the machine	15
4 Permanent settings in programming mode	16
Inserting and activating the filter	16
Setting the water hardness	16
5 Maintenance	17
Cleaning the machine.....	17
Descaling the machine	18
Changing the filter.....	19
Descaling the water tank.....	20
Cleaning the bean container	20
6 Messages on symbol display	21
7 Troubleshooting	22
8 Transport and environmentally friendly disposal	23
Transport / Emptying the system	23
Disposal	23
9 Technical data	23
10 Index	24
11 JURA contact details / Legal information	26

Symbol description

Warnings



This is the safety alert symbol. It is used to alert you to potential personal injury hazards. Obey all safety messages that follow this symbol to avoid possible injury or death.

DANGER

DANGER indicates a hazardous situation which, if not avoided, will result in death or serious injury.

WARNING

WARNING indicates a hazardous situation which, if not avoided, could result in death or serious injury.

CAUTION

CAUTION, used with the safety alert symbol, indicates a hazardous situation which, if not avoided, could result in minor or moderate injury.

NOTICE

NOTICE is used to address practices not related to personal injury.

Symbols used

- ▶ **Prompt to take action.** This symbol means that you are being prompted to perform some action.

- i** **Information** and tips to make it even easier to use your ENA.

IMPORTANT SAFEGUARDS

Follow the basic safety precautions

When using electrical appliances, basic safety precautions shall always be followed, to reduce the risk of fire, electric shock, and/or injury to persons, including the following:

- Read all instructions.
- Do not touch hot surfaces. Use handles or knobs.
- To protect against fire, electric shock and injury to persons, do not immerse power cord, plugs, or body of machine in water or other liquid.
- Close supervision is necessary when any appliance is used by or near children.
- Unplug from outlet when not in use and before cleaning. Allow to cool before putting on or taking off parts, and before cleaning the appliance.
- Do not operate any appliance with a damaged cord or plug or after the appliance malfunctions, or has been damaged in any manner. Return appliance to the nearest authorized service facility for examination, repair or adjustment.
- The use of an accessory attachment not recommended by the appliance manufacturer may result in fire, electric shock, or injury to persons.
- Do not use outdoors.
- Do not let the cord hang over the edge of a table or counter, or touch hot surfaces.
- Do not place on or near a hot gas or electric burner, or in a heated oven.
- To disconnect, turn any control to 'OFF' then remove plug from wall outlet.
- Do not use appliance for other than intended use.
- Use extreme caution when dispensing hot steam, hot water or hot coffee.
- For household use only.

SAVE THESE INSTRUCTIONS.

Pass them on to any subsequent user.

Intended use The appliance is designed and intended for household use only. It shall only be used for coffee preparation and to heat milk and water, according to these instructions. Use for any other purpose will be deemed improper. JURA Elektroapparate AG cannot accept any responsibility for the consequences of improper use.

People, including children, who

- do not have the physical, sensory or mental capabilities to use the appliance safely or
- are inexperienced or lack knowledge in how to use the appliance safely

must be supervised by a responsible person when using it, or must be instructed in how to use it correctly.

Special power cord set instructions

- The power cord is provided to reduce the risk resulting from becoming entangled in or tripping over a long cord.
- The cord shall be arranged so that it will not drape over the counter top or table top where it can be pulled on by children or tripped over.
- This appliance has a 3-pin grounded plug.
- Do not modify the plug in any way.

Do NOT use extension cords.

If the user chooses to use an extension cord,

- the marked electrical rating of the extension cord shall be at least as great as the electrical rating of the appliance, and
- if the appliance is of the grounded type, the extension cord shall be a grounding type 3-wire cord, and
- the longer cord shall be arranged so that it will not drape over the counter top or tabletop where it can be pulled on by children or tripped over.

 **WARNING**



To reduce the risk of fire or electric shock, DO NOT remove any service covers. DO NOT modify the appliance in any way that is not described in these instructions. NO user serviceable parts included. Repair MUST be done by authorized personnel only.

In the event of signs of damage, for example if there is a smell of burning, unplug the machine immediately from outlet and contact JURA customer service.

IMPORTANT SAFEGUARDS

⚠ CAUTION

This appliance is for household use. Any servicing other than cleaning and user maintenance shall be performed by an authorized service representative:

- Do not immerse base in water or try to disassemble.
- Do not put the appliance or any individual parts in the dishwasher.
- Check voltage to be sure that the voltage indicated on the name plate complies with your voltage. The name plate is located on the underside of the appliance.
- Never use warm or hot water to fill the water container. Use cold water only.
- Keep your hands and the cord away from hot parts of the appliance during operation.

NOTICE



- Never clean with scouring powders or hard implements.
- Ensure that the ventilation slots are not covered.
- Never pull out the drip tray during the brewing process. Only pull the drip tray when the display instructs you or when the appliance is ready for use.

NEVER DO (or you will void your warranty protection):

- Never fill instant coffee, chocolate mix etc. into the bean container or ground coffee funnel (filler funnel for ground coffee). It will damage the functioning of the brewing chamber.
- Never fill sugar coated coffee beans into the bean container. In case of doubt, call your dealer.
- Never fill anything other than coffee beans into the bean container (no chocolate, no rice, no nuts, no spices, nothing other than roasted coffee beans).
- Never fill frozen beans into the bean container. If you store beans in the freezer, let them thaw 3 to 4 hours before filling them into the bean container.
- Never fill anything but fresh, cold and clean water into the water tank, except when decalcifying.
- Never use mineral or carbonated water. You can use tap water, bottled water, spring water and reverse osmosis water.
- Never do anything with the machine which is not described in these instructions. In case of doubt, call your dealer.

– intentionally blank –

Control elements

Control elements

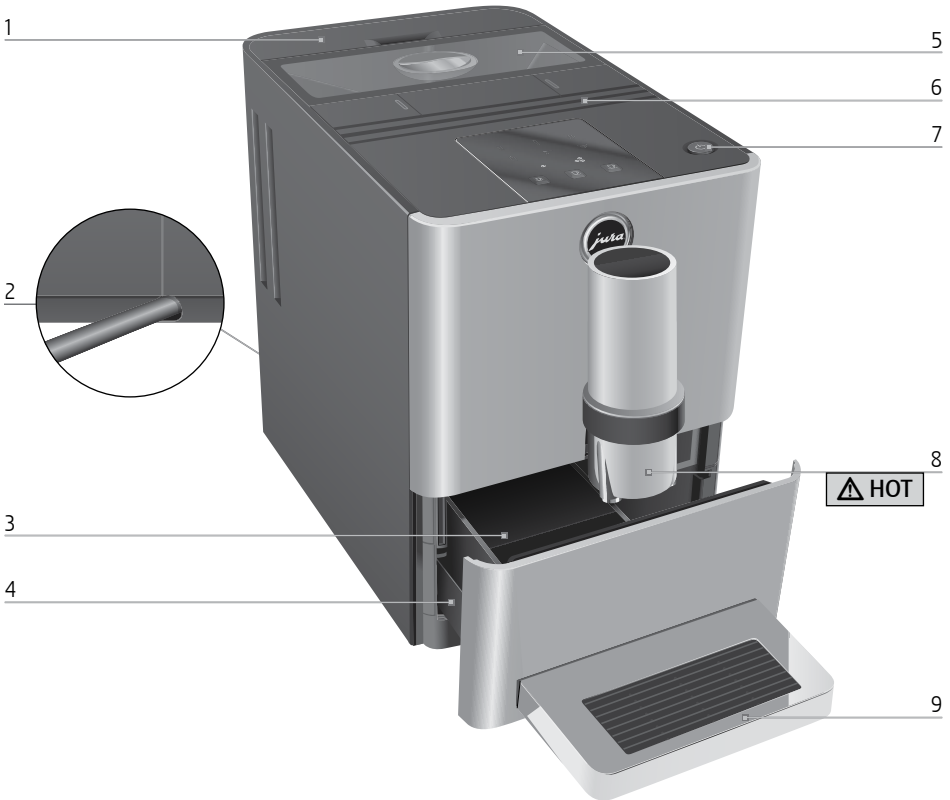
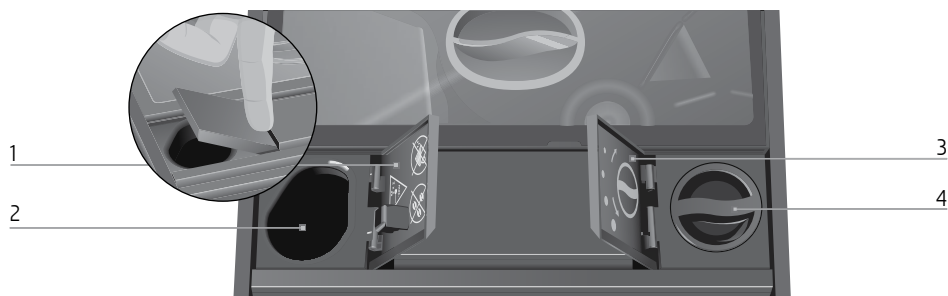

Figure: Your machine may look different to the one shown.

- | | | | |
|---|----------------------------------|---|--|
| 1 | Water tank | 5 | Bean container with aroma preservation cover |
| 2 | Power cord (back of the machine) | 6 | Ventilation slots |
| 3 | Coffee grounds container | 7 | On/Off button |
| 4 | Drip tray | 8 | Rotating coffee spout (height-adjustable) |
| | | 9 | Cup platform |



- 1 Cover for powder chute for ground coffee
2 Powder chute for ground coffee

- 3 Cover cap for grinder adjustment switch
4 Grinder adjustment switch



- 1 Symbol display
- Descaling symbol
 - Filter symbol
 - Cleaning symbol
 - Water Tank symbol
 - Ground Coffee symbol
 - Coffee Grounds Container symbol

- Coffee strength 'normal'
- Coffee strength 'strong'
- Ristretto symbol
- Espresso symbol
- Coffee symbol

1 Preparing and using for the first time

This chapter provides you with the information you need to use your ENA without any problems. You will prepare your ENA step-by-step to enjoy your first perfect cup of coffee.

- i** Visit us on the internet. On the **JURA website** (www.jura.com) you will find interesting and up-to-date information on your ENA and every aspect of coffee.

Setting up the machine

When setting up your ENA, please note the following:

- Place the machine on a horizontal surface that is not sensitive to water.
- Choose a spot for your ENA which protects the machine against overheating. Ensure that the ventilation slots are not covered.



Filling the bean container

NOTICE

Coffee beans which have been treated with additives (e.g. sugar), ground coffee or freeze-dried coffee will damage the grinder.

- ▶ Only use roasted, untreated coffee beans to fill the bean container.
- ▶ Remove the aroma preservation cover of the bean container.
- ▶ Remove any dirt or foreign objects from inside the bean container.
- ▶ Fill the bean container with coffee beans.
- ▶ Close the bean container.

First-time use

When using the machine for the first time, you can choose whether you want to operate ENA **with** or **without** the CLEARYL Blue filter cartridge. If the water hardness is 10 °dH or more, we recommend using the filter cartridge. If you do not know the hardness of your water, you can find this out first (see Chapter 1 'Preparing and using for the first time – Determining the water hardness').



- i** The On/Off button also acts as a power switch. When the ENA is switched off, the machine does not consume standby energy.

⚠ WARNING

If the machine is operated with a defective power cord, there is a danger of potentially fatal electric shock.



- ▶ Never use a machine which is damaged.
- ▶ Never use a machine which has a defective power cord.

Precondition: Bean container is filled.

- ▶ Insert the power plug into a power socket.
- ▶ Press the On/Off button to switch the machine on.
The Descaling symbol  and the Filter symbol  are lit up.

- i** Now decide whether you want to operate your ENA **with** or **without** a CLEARYL Blue filter cartridge.

First-time use with filter cartridge activation

- ▶ Touch the Filter symbol .
The Water Tank symbol  lights up.
- ▶ Remove the water tank.
- ▶ Open the filter holder.

- ▶ Insert the filter cartridge into the water tank, exerting slight pressure.







- ▶ Close the filter holder. It will click into place audibly.

i After three months, the filter will cease to work. Set the date on the date plate on the filter holder in the water tank.



- ▶ Fill the water tank with fresh, cold water and reinsert it.

The Filter symbol  lights up.

- ▶ Touch the Filter symbol.





The , ,  and  symbols flash. The filter is rinsed and the water flows directly into the drip tray.

Rinsing of the filter stops automatically. The machine heats up.

The ,  and  symbols flash. The machine is rinsed, water flows out of the coffee spout. The rinse stops automatically.







The Coffee Grounds Container symbol  lights up.









- ▶ Empty the coffee grounds container and drip tray and rinse with warm water.
- ▶ Reinsert the coffee grounds container and the drip tray.

The Ristretto , Espresso  and Coffee  symbols and the symbol for 'strong' coffee strength  light up. Your ENA is ready for use.

First-time use without filter cartridge activation



If you do not want to use the CLEARYL Blue filter cartridge, you will need to set the water hardness. The following water hardness settings are available:

Water hardness	Symbol(s) shown in display
Level 1: 1-15 °dH	1 symbol illuminated 
Level 2: 16-23 °dH	2 symbols illuminated  
Level 3: 24-30 °dH	3 symbols illuminated   







- ▶ Touch the Descaling symbol. The ,  and  symbols light up.
- ▶ Touch the ,  or  symbol to set the water hardness, e.g. symbol  for 'level 1'. The  and  symbols light up.

- ▶ Touch the Descaling symbol. The Water Tank symbol  lights up.
- ▶ Place a receptacle under the coffee spout.
- ▶ Remove the water tank.
- ▶ Fill the water tank with fresh, cold water and reinsert it.



The ,  and  symbols flash. The system fills with water and the water flows directly into the drip tray.

The operation stops automatically. The machine heats up.

The ,  and  symbols flash. The machine is rinsed, water flows out of the coffee spout. The rinse stops automatically. The Ristretto , Espresso , Coffee  and Coffee strength 'strong'  symbols light up. Your ENA is ready for use.

2 Preparation

Filling the water tank

Daily maintenance of the machine and hygiene when handling coffee and water are key to a perfect coffee result in the cup every time. You should therefore change the water **daily**.

NOTICE

Milk, sparkling mineral water or other liquids can damage the water tank or the machine.

- ▶ Only fill the water tank with fresh, cold water.
- ▶ Remove the water tank and rinse with cold water.



- ▶ Fill the water tank with fresh, cold water and reinsert it.

Determining the water hardness

You can find out what the water hardness is by using the Aquadur® test strip supplied as standard.

- ▶ Hold the test strip briefly (for one second) under running water.
- ▶ Shake off the water.
- ▶ Wait for about one minute.
- ▶ You will then be able to read the degree of water hardness from the discoloration of the Aquadur® test strip and the description on the packaging.

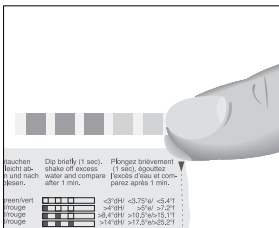

The water hardness can now be set.

2 Preparation

⚠ WARNING

Hot coffee can cause scalding. Scalding is a serious burn.

- ▶ Use extreme care when handling hot liquid.
- ▶ Allow liquid to cool down before drinking.
- ▶ In the event of scalding, rinse affected area with cold water and seek medical attention.
- ▶ Keep children AWAY.

- i** While a specialty coffee is being prepared, you can stop preparation at any time. Simply touch the symbol for the product in question.
- i** If preparing two specialty coffees, you have to stop each brewing operation separately.
- i** Before and during the grinding operation you can select the **coffee strength** of the ristretto ☺, espresso ☺ and coffee ☺ specialty coffees: 'normal' (☺), 'strong' (☺).

The machine always uses the **preset amount of water** for the type of coffee in question. You can change this setting (see Chapter 2 'Preparation – Permanently setting the amount of water for the cup size').

Your ENA has an **Energy Save Mode**: Soon after the last preparation, the ENA stops heating up. To indicate that the machine is in energy-saving mode, after about 5 minutes the brightness of all the symbols is reduced. The ENA must heat back up before the next preparation.

Coffee tastes best served hot. A cold porcelain cup cools the beverage – and impairs the taste. We therefore recommend prewarming the cups. The full coffee aroma can develop only in prewarmed cups. You can purchase a JURA cup warmer from your specialized dealer.

Rotating coffee spout

Your ENA has a rotating coffee spout for preparing **one** or **two cups** of your desired specialty coffee:

- '1 cup' position



- '2 cups' position



- i** The two coffee spout positions clearly engage.
- i** If the coffee spout is in the '2 cups' position, the desired specialty coffee is prepared twice in succession. The coffee strength can only be set before the first product is prepared.

Ristretto, espresso and coffee

Ristretto ☺, espresso ☺ and coffee ☺ are prepared following this model.

Example: Proceed as follows to prepare one coffee.

Precondition: Your ENA is ready for use.

- ▶ Turn the coffee spout to the '1 cup' position.



- ▶ Place a cup under the coffee spout.
- ☺ ▶ Touch the Coffee symbol to start preparation. The Coffee ☺ and Coffee strength (☺ or ☺) symbols flash, the preset amount of water flows into the cup. Preparation stops automatically. Your ENA is once more ready for use.
- i** To prepare **two coffees**, turn the coffee spout to the '2 cups' position. Press the Coffee symbol ☺ to start preparation of two cups.

Permanently setting the amount of water for the cup size

It is easy to make permanent settings for the amount of water for all specialty coffees according to the cup size. Adjust the amount once as shown in the following example. Every time you prepare a drink in the future, this amount of water will be dispensed.

- i** The process for adapting the amount of water to the cup size only works when **preparing one cup**. When two cups are prepared, the set amount is doubled.

Example: Permanently adjust the amount of espresso to the cup size.

Precondition: Your ENA is ready for use.

- ▶ Turn the coffee spout to the '1 cup' position.



- ▶ Place a cup under the dual spout.
- ☺ ▶ Touch the Espresso symbol **for about 3 seconds** until the Ristretto ☺ and Coffee ☺ symbols appear again.

2 Preparation

- ▶ **Release** the Espresso symbol.
The espresso is prepared. The Espresso ☒ and Coffee strength symbols (☉ or ☿) flash.
- ▶ Touch the Espresso symbol as soon as there is enough espresso in the cup.
Preparation stops. The amount of water for one espresso is permanently stored. The Espresso ☒ and Coffee strength symbols (☉ or ☿) flash until the machine is ready for use again.

i You can alter this setting at any time by repeating the above procedure.

Adjusting the grinder

You can adjust the grinder on a continuous scale to suit the degree of roast of your coffee.

NOTICE

If you adjust the consistency of grind when the grinder is not operating, the grinder adjustment switch could be damaged.

- ▶ Only adjust the consistency of grind when the grinder is running.

i For a coarser consistency of grind, turn the switch to the left, for a finer grind, turn it to the right.

The consistency of grind is correct if the coffee flows regularly from the coffee spout. In addition a fine, thick crema forms.

Example: Change the consistency of grind **during** the preparation of a 'strong' espresso.

- ▶ Turn the coffee spout to the '1 cup' position.



- ▶ Place a cup under the coffee spout.
- ▶ Open the cover of the grinder adjustment switch.

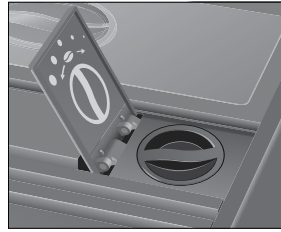

- ▶ Touch the Coffee strength 'strong' ☿ symbol.
The Coffee strength 'strong' ☿ symbol lights up.
- ▶ Touch the Espresso symbol to start preparation.
- ▶ Turn the grinder adjustment switch to the desired position **while** the grinder is running.
The preset amount of water flows into the cup. Preparation stops automatically.
- i** Please note that changing the consistency of grind only takes effect for the second coffee preparation.

Ground coffee

You can choose to use a second coffee variety, for example decaffeinated coffee, with the powder chute for ground coffee.

- i** Use ground coffee which is not ground too finely. Very fine coffee can block up the system so that the coffee only comes out in drips.
- i** It is not possible to prepare two cups with ground coffee. If the coffee spout is in the '2 cups' position, just one cup is prepared.
- i** Never add more than one level measuring spoon of ground coffee.
- i** The desired specialty coffee must be prepared within approximately one minute after filling with the ground coffee. Otherwise the ENA stops the operation and is once more ready for use.

- i** If you did not add a sufficient amount of ground coffee, the ☉, ☽, ☾ and ☿ symbols flash and the ENA stops the operation.

All specialty coffees with ground coffee are prepared following this model.

Example: Prepare a cup of coffee using ground coffee.

Precondition: Your ENA is ready for use.

- ▶ Place a cup under the coffee spout.
- ▶ Open the powder chute for ground coffee. The Ground Coffee symbol ☿ lights up.
- ▶ Place the filler funnel for ground coffee on the powder chute.

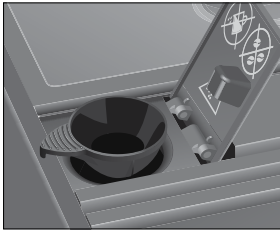

- ▶ Place one level measuring spoon of ground coffee into the filler funnel.
- ▶ Close the powder chute for ground coffee. The ☉, ☽, ☾ and ☿ symbols flash. The ☉, ☽ and ☾ symbols light up.
- ☽ ▶ Touch the Coffee symbol to start preparation. The Coffee symbol ☽ flashes, the preset amount of water flows into the cup. Preparation stops automatically. Your ENA is once more ready for use.

3 Daily operation

Switching on the machine

Daily maintenance of the machine and hygiene when handling coffee and water are key to a perfect coffee result in the cup every time. You should therefore change the water **daily**.

When the machine is switched on, it is automatically rinsed.

- ▶ Place a receptacle under the coffee spout.
- ☽ ▶ Press the On/Off button to switch the machine on. The ☉, ☽ and ☾ symbols flash, the machine heats up. The machine is rinsed, water flows out of the coffee spout. The rinse stops automatically. Your ENA is ready for use.

Daily maintenance

To ensure that you get many years of reliable service out of your ENA and to guarantee the optimum coffee quality, the machine requires daily maintenance.

- ▶ Remove the drip tray.
- ▶ Empty the coffee grounds container and drip tray and rinse with warm water.
- ▶ Reinsert the coffee grounds container and the drip tray.
- ▶ Rinse the water tank with clean water.
- ▶ Wipe the surface of the machine with a clean, soft, damp cloth (e.g. microfiber cloth).

Switching off the machine

When the ENA is switched off, the system is automatically rinsed if a specialty coffee has been prepared.

- ▶ Place a receptacle under the coffee spout.
- ☽ ▶ Press the On/Off button. The ☉, ☽ and ☾ symbols flash. The machine is rinsed, water flows out of the coffee spout. The rinse stops automatically. Your ENA is switched off.

- i** When the ENA is switched off with the On/Off button, the machine does **not consume standby energy**.
- i** If no action is performed on the machine for 30 minutes, the ENA will **automatically** switch off to save energy.



4 Permanent settings in programming mode



Inserting and activating the filter

Your ENA no longer has to be descaled if you are using the CLEARLYL Blue filter cartridge. If you did not activate the filter cartridge the first time you used the machine, you can do this now as follows.

- i** Perform the 'inserting the filter' operation without any interruptions. This will ensure that your ENA always produces its best.

Precondition: Your ENA is ready for use.

- ▶ Touch the  and  symbols for **approximately 2 seconds**.

The , ,  and  symbols light up brightly.

-  ▶ Touch the Filter symbol for **approximately 2 seconds**.

The Water Tank symbol  lights up.

- ▶ Remove the water tank.
- ▶ Open the filter holder.
- ▶ Insert the filter cartridge into the water tank, exerting slight pressure.



- ▶ Close the filter holder. It will click into place audibly.

- i** After three months, the filter will cease to work. Set the date on the date plate on the filter holder in the water tank.



- ▶ Fill the water tank with fresh, cold water and reinsert it.

The Coffee Grounds Container symbol  lights up.

- ▶ Empty the drip tray and coffee grounds container and reinsert them.



The Filter symbol  lights up.

-  ▶ Touch the Filter symbol to start rinsing of the filter

The ,  and  symbols flash. The filter is rinsed.

Rinsing of the filter stops automatically. The Coffee Grounds Container symbol  lights up.

- ▶ Empty the drip tray and coffee grounds container and reinsert them.







The ,  and  symbols flash, the machine heats up. Your ENA is once more ready for use.





Setting the water hardness

- i** If you are using the CLEARLYL Blue filter cartridge and have activated it, there is no need to set the water hardness.



The harder the water is, the more frequently the ENA needs to be descaled. It is therefore important to set the water hardness accurately.





The following water hardness settings are available:

Water hardness	Symbol(s) shown in display
Level 1: 1–15 °dH	1 symbol illuminated 
Level 2: 16–23 °dH	2 symbols illuminated  
Level 3: 24–30 °dH	3 symbols illuminated   



Example: Change the water hardness setting from 'level 2' ( ) to 'level 3' (  .

Precondition: Your ENA is ready for use.

- ▶ Touch the  and  symbols for **approximately 2 seconds**.

The , ,  and  symbols light up brightly.

-  ▶ **Briefly** touch the Descaling symbol.

The ,  and  symbols light up.

-  ▶ Touch the Coffee symbol.

The , ,  and  symbols light up.

- ▶ Touch the Descaling symbol to confirm that you want to set the water hardness to 'level 3'.
Your ENA is once more ready for use.

5 Maintenance

⚠ WARNING

Use of maintenance products that are harmful to health and discharge of liquids during maintenance program. Harmful if swallowed. Irritating to eyes and skin.

- ▶ Keep children AWAY.
- ▶ Keep children away from the machine while it is performing a maintenance program.
- ▶ Avoid contact with skin and eyes.
- ▶ Avoid generation of dust. Do not inhale dust.
- ▶ When using do not eat or drink.
- ▶ Keep maintenance products away from food, drink and animal food.
- ▶ Keep container tightly closed and dry. Keep in a cool place.

Your ENA has the following integrated maintenance programs:

- Cleaning the machine
- Descaling the machine
- Changing the filter

Cleaning the machine

After 180 preparations or 80 switch-on rinses, the ENA will prompt you to clean it.

⚠ WARNING

Non-recommended (e.g. liquid) cleaning agents may contain substances that could damage the machine or leave residues.

- ▶ Use only original JURA cleaning tablets. These are specially formulated for your machine.

⚠ WARNING

Harmful and irritating cleaning agent. Harmful if swallowed. Irritating to eyes and skin.

- ▶ Keep children AWAY.
- ▶ Avoid contact with skin and eyes.
- ▶ Avoid generation of dust. Do not inhale dust.
- ▶ After contact with skin, wash immediately with plenty of water. In case of skin irritation, seek medical advice.
- ▶ After eye contact, immediately flush eyes with plenty of water and seek medical advice.
- ▶ If swallowed, rinse mouth immediately and drink large quantities of water. Do not induce vomiting. Seek medical advice immediately and show label.

- i** The cleaning program lasts approximately 15 minutes.
- i** Do not interrupt the cleaning program. The quality of cleaning will be impaired if you do so.
- i** JURA cleaning tablets are available from specialized dealers.

Precondition: Your ENA is ready for use. The Cleaning symbol ☼ lights up.

- ▶ Turn the coffee spout to the '2 cups' position.



- ☼ ▶ Touch the Cleaning symbol for **approximately 2 seconds**. The Coffee Grounds Container symbol ☼ lights up.
- ▶ Empty the drip tray and coffee grounds container and reinsert them. The Cleaning symbol ☼ lights up.

5 Maintenance

- ▶ Place a receptacle under the coffee spout.
- ☼ ▶ Touch the Cleaning symbol.
The ☼, ☼, ☼ and ☼ symbols flash, water flows out of the coffee spout.
The operation is interrupted, the Ground Coffee symbol ☼ lights up.
- ▶ Open the powder chute for ground coffee and drop in a JURA cleaning tablet.

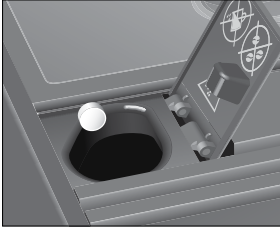

- ▶ Close the powder chute for ground coffee.
The Cleaning symbol ☼ lights up.
- ☼ ▶ Touch the Cleaning symbol.
The ☼, ☼, ☼ and ☼ symbols flash, water flows out of the coffee spout several times.
The operation is interrupted, the Coffee Grounds Container symbol ☼ lights up.
- ▶ Empty the drip tray and coffee grounds container and reinsert them.
The ☼, ☼ and ☼ symbols flash. The machine heats up.
Your ENA is once more ready for use.

Cleaning the machine without a prompt: You can initiate the 'Cleaning the machine' operation manually at any time as long as the machine is ready for use. Touch the ☼ and ☼ symbols **simultaneously for approx. 2 seconds**. The ☼, ☼, ☼ and ☼ or ☼ symbols light up brightly. Continue with the **first prompt** (indicated by ▶) as described in this section.

Descaling the machine

The ENA builds up deposits of limescale over time and automatically prompts you to descale it when necessary. The degree of calcification depends on the hardness of your water.

⚠ WARNING

Non-recommended descaling agents (e.g. vinegar) may contain substances that could damage the machine or leave residues.

- ▶ Use only original JURA descaling tablets.
These are specially formulated for your machine.

⚠ WARNING

Harmful and irritating descaling agent. Harmful if swallowed. Irritating to eyes and skin.

- ▶ Keep children AWAY.
- ▶ Avoid contact with skin and eyes.
- ▶ Avoid generation of dust. Do not inhale dust.
- ▶ After contact with skin, wash immediately with plenty of water. In case of skin irritation, seek medical advice.
- ▶ After eye contact, immediately flush eyes with plenty of water. Remove contact lenses. Seek medical advice.
- ▶ If swallowed, rinse mouth immediately and drink large quantities of water. Do not induce vomiting. Seek medical advice immediately and show label.

NOTICE



If the descaling operation is interrupted, there may be damage to the machine.

- ▶ Allow the descaling program to run to the end.







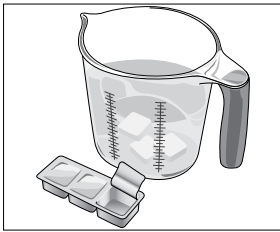

- i** The descaling program lasts approximately 40 minutes.
- i** JURA descaling tablets are available from specialized dealers.
- i** If you use a CLEARYL Blue filter cartridge and this is activated, you will not be prompted to descale.









- i** If the descaling agent comes into contact with sensitive surfaces (e.g. marble), damage cannot be ruled out. Clean up any splashes immediately.

Precondition: Your ENA is ready for use. The Descaling symbol  lights up.







-  ▶ Touch the Descaling symbol **for approximately 2 seconds**. The Coffee Grounds Container symbol  lights up.
- ▶ Empty the drip tray and coffee grounds container and reinsert them. The Water Tank symbol .
- ▶ Remove and empty the water tank.
- ▶ Completely dissolve the contents of one blister (three JURA descaling tablets) in a receptacle holding 17 oz (500 ml) of water. This may take several minutes.



- ▶ Pour the solution into the **empty** water tank and reinsert the tank. The Descaling symbol  lights up.
-  ▶ Touch the Descaling symbol. The , ,  and  symbols flash, water flows directly into the drip tray. The operation is interrupted, the Coffee Grounds Container symbol  flashes.
- ▶ Empty the drip tray and coffee grounds container and reinsert them. The Water Tank symbol  lights up.
- ▶ Remove the water tank and **rinse thoroughly**.
- ▶ Fill the water tank with fresh, cold water and reinsert it. The Descaling symbol  lights up.

-  ▶ Touch the Descaling symbol. The , ,  and  symbols flash, water flows directly into the drip tray. The ,  and  symbols flash, water flows out of the drip tray. The operation is interrupted, the Coffee Grounds Container symbol  lights up.
- ▶ Empty the drip tray and coffee grounds container and reinsert them. Your ENA is once more ready for use.



- i** If the descaling operation stops unexpectedly, rinse the water tank thoroughly.

Descaling the machine without a prompt: You can initiate the 'Descaling the machine' operation manually at any time as long as the machine is ready for use. Touch the  and  symbols **simultaneously for approx. 2 seconds**. The , ,  and  symbols light up brightly. Continue with the **first prompt** (indicated by ▶) as described in this section.

Changing the filter

- i** After 2000 oz (60 liters) of water have flowed through, the filter will cease to work. Your ENA will automatically prompt you to change the filter.
- i** After three months, the filter will cease to work. Set the date on the date plate on the filter holder in the water tank.
- i** If the CLEARYL Blue filter cartridge is not activated in programming mode, you will not be prompted to change the filter.

Precondition: Your ENA is ready for use. The Filter symbol  lights up.

-  ▶ Touch the Filter symbol **for approximately 2 seconds**. The Water Tank symbol  lights up.
- ▶ Remove the water tank.
- ▶ Open the filter holder and remove the old filter cartridge.

5 Maintenance

- ▶ Insert a new filter cartridge into the water tank, exerting slight pressure.

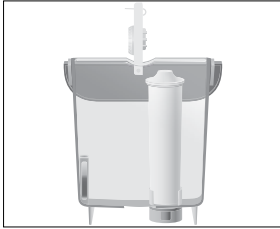

- ▶ Close the filter holder. It will click into place audibly.

i After three months, the filter will cease to work. Set the date on the date plate on the filter holder in the water tank.

- ▶ Fill the water tank with fresh, cold water and reinsert it.

The Coffee Grounds Container symbol ☞ lights up.

- ▶ Empty the drip tray and coffee grounds container and reinsert them.

The Filter symbol ⏴ lights up.

- ⏴ ▶ Touch the Filter symbol to start rinsing of the filter.

The ☞, ☞, ☞ and ⏴ symbols flash. The filter is rinsed. Water flows directly into the drip tray.

Rinsing of the filter stops automatically. The Coffee Grounds Container symbol ☞ lights up.

- ▶ Empty the drip tray and coffee grounds container and reinsert them.

The machine heats up. Your ENA is once more ready for use.

Changing the filter without a prompt: If the filter is activated, you can initiate the 'Changing the filter' operation manually at any time as long as the machine is ready for use. Touch the ☞ and ☞ symbols simultaneously for approx. 2 seconds.

The ☞, ☞, ☞ and ⏴ symbols light up brightly. Continue with the **first prompt** (indicated by ▶) as described in this section.

Descaling the water tank

Limescale deposits may form in the water tank. To ensure correct function of the machine, descale the water tank from time to time.















- ▶ Remove the water tank.
- ▶ If you use a CLEARYL Blue filter cartridge, remove it.
- ▶ Descale the tank with a mild conventional descaling agent in accordance with the manufacturer's instructions.
- ▶ Rinse the water tank thoroughly.
- ▶ If you use a CLEARYL Blue filter cartridge, reinsert it.
- ▶ Fill the water tank with fresh, cold water and reinsert it.

Cleaning the bean container







Coffee beans may be covered with a slight oil film which remains on the walls of the bean container. These traces may negatively affect the coffee result. For this reason clean the bean container from time to time.

- ⏻ ▶ Press the On/Off button to switch the machine off.
- ▶ Disconnect the power plug.
- ▶ Remove the bean container cover.
- ▶ Remove the coffee beans with a vacuum cleaner.
- ▶ Clean the bean container with a soft, dry cloth.
- ▶ Fill the bean container with fresh coffee beans, then close the bean container cover.

6 Messages on symbol display

Message (Symbol(s) shown in display)	Cause/Result	Action
The Water Tank symbol  lights up.	The water tank is empty or not correctly inserted. You cannot prepare any products.	<ul style="list-style-type: none"> ▶ Fill the water tank (see Chapter 1 'Preparing and using for the first time – Filling the water tank'). ▶ Insert the water tank.
The Coffee Grounds Container symbol  lights up.	The coffee grounds container is full. No specialty coffees can be prepared.	▶ Empty the coffee grounds container and the drip tray (see Chapter 3 'Daily operation – Daily maintenance').
The Coffee Grounds Container symbol  flashes.	The drip tray is not inserted correctly or is not inserted at all. You cannot prepare any products.	▶ Insert the drip tray.
The  ,  ,  ,  and  symbols flash.	The aroma preservation cover for the bean container is not fitted or not fitted correctly.	▶ Fit the aroma preservation cover correctly.
The  ,  ,  and  or  symbols light up brightly.	You are in programming mode.	▶ Touch the  or  symbol to exit programming mode. Your ENA is once more ready for use.
The ENA is ready for use and the Cleaning symbol  lights up.	The ENA is prompting you to clean it.	▶ Perform cleaning (see Chapter 5 'Maintenance – Cleaning the machine').
The ENA is ready for use and the Descaling symbol  lights up.	The ENA is prompting you to descale it.	▶ Perform descaling (see Chapter 5 'Maintenance – Descaling the machine').
The ENA is ready for use and the Filter symbol  lights up.	After 2000 oz (60 liters) of water have flowed through the CLEARYL Blue filter cartridge, it will cease to work.	▶ Replace the CLEARYL Blue filter cartridge (see Chapter 5 'Maintenance – Changing the filter').
Preparing ground coffee: after ground coffee is added to the machine, the  ,  ,  and  symbols flash briefly.	There is insufficient ground coffee in the machine; the ENA stops the operation.	▶ The next time you prepare a beverage, add more ground coffee (see Chapter 2 'Preparation – Ground coffee').

7 Troubleshooting

Problem	Cause/Result	Action
Coffee only comes out in drips when it is being prepared.	Coffee or ground coffee has been ground too finely and is blocking the system.	► Set the grinder to a coarser setting or use coarser ground coffee (see Chapter 2 'Preparation – Adjusting the grinder').
The Water Tank symbol  lights up even though the tank is full.	The water tank float is trapped.	► Descal the water tank (see Chapter 5 'Maintenance – Descaling the water tank').
The  and  symbols flash alternately.	The system must be filled with water.	► Fill the water tank (see Chapter 1 'Preparing and using for the first time – Filling the water tank'). ► Touch the  or  symbol. The system fills up with water.
Grinder is making a very loud noise.	There are foreign objects in the grinder.	► Contact customer support in your country (see Chapter 11 'JURA contact details / Legal information').
When the ENA is switched on, the Cleaning symbol  flashes for 5 seconds. The machine then switches off.	If the machine was exposed to the cold for a long period of time, heating is disabled for safety reasons.	► Warm the machine at room temperature.
When the ENA is switched on, one of the symbols (other than ) flashes for 5 seconds. The machine then switches off.	–	► Contact customer support in your country (see Chapter 11 'JURA contact details / Legal information').

i If you were unable to solve the problem, contact customer support in your country (see Chapter 11 'JURA contact details / Legal information').

8 Transport and environmentally friendly disposal

Transport / Emptying the system

Keep the packaging for your ENA. It should be used to protect the machine during transport.

In order to protect the ENA from frost during transport, the system must be emptied.

Precondition: Your ENA is ready for use.

- ▶ Place a receptacle under the coffee spout.
- ▶ Touch the ☉ and ☼ symbols for **approximately 2 seconds**.

The ☉, ☼, ☽ and ☿ or ☽ symbols light up brightly.

- ▶ Remove and empty the water tank. The ☽, ☽ and ☽ symbols light up.

- ☽ ▶ Touch the Espresso symbol. Hot water will continue to flow until the system is empty. The Water Tank symbol ☽ lights up.

- ⏻ ▶ Press the On/Off button to switch the machine off.

Disposal

Please dispose of old machines in an environmentally neutral way.



9 Technical data

Voltage	120 V ~, 60 Hz
Power	1450 W
Conformity mark	
Energy consumption Energy Save Mode 'on' (display symbols slightly less bright)	approx. 4.0 Wh
Pump pressure	Static, max. 15 bar
Holding capacity of water tank (without filter)	37.2 oz (1.1 l)
Holding capacity of bean container	4.4 oz (125 g)
Holding capacity of coffee grounds container	approx. 9 servings
Cord length	Approx. 43.3 in. (Approx. 1.1 m)
Weight	Approx. 19.6 lb (Approx. 8.9 kg)
Dimensions (W × H × D)	9.0 × 12.7 × 17.5 in. (23 × 32.3 × 44.5 cm)

Information for testers (repeat test in accordance with DIN VDE 0701-0702): The central grounding point (CGP) is located on the underside of the machine, right next to the power cord's connection point.

Directives

The machine complies with the following directives:

- Standard UL 1082
- Canadian Standard CSA C22.2 No. 64

10 Index

A

- Addresses 26
- Aroma preservation cover
 - Bean container with aroma preservation cover 8

B

- Bean container
 - Bean container with aroma preservation cover 8
 - Cleaning 20
 - Filling 10
- Bus bar
 - Technical data 23
- Button
 - On/Off button 8

C

- Central grounding point 23
- Cleaning
 - Bean container 20
 - Machine 17
- CLEARYL Blue filter cartridge
 - Changing 19
 - Inserting and activating the filter 16
- Coffee 13
- Coffee grounds container 8
- Coffee spout
 - Rotating coffee spout 8, 13
- Consistency of grind
 - Adjusting the grinder 14
 - Grinder adjustment switch 9
- Contact details 26
- Cup platform 8
- Customer support 26

D

- Descaling
 - Machine 18
 - Water tank 20
- Display
 - Symbol display 9
- Display, messages 21
- Disposal 23
- Drip tray 8

E

- Emptying the system 23
- Energy Save Mode 12
- Errors
 - Troubleshooting 22
- Espresso 13

F

- Filling
 - Bean container 10
 - Water tank 12
- Filter
 - Changing 19
 - Inserting and activating the filter 16
- First-time use 10
 - With filter cartridge activation 10
 - Without filter cartridge activation 11

G

- Grinder adjustment switch 9
- Ground coffee 14
 - Powder chute for ground coffee 9
- Grounding point 23

H

- Hotline 26

I

- Important safeguards
 - Safety 4
- Instant coffee
 - Ground coffee 14
- Internet 10

J

- JURA
 - Contact details 26
 - Internet 10
 - website 10

M

- Machine
 - Cleaning 17
 - Descaling 18
 - Setting up 10
 - Switching off 15
 - Switching on 15
- Maintenance 17
 - Daily maintenance 15
- Messages on display 21

P

- Permanently setting the water for the cup size 13
- Permanent settings in programming mode 16
- Powder chute
 - Powder chute for ground coffee 9
- Power cord 8
- Preparation 12
 - Coffee 13
 - Espresso 13
 - Ground coffee 14
 - Ristretto 13
- Problems
 - Troubleshooting 22
- Programming mode 16
 - Setting the water hardness 16

R

- Ristretto 13

S

- Safety
 - Important safeguards 4
- Settings
 - Permanent settings in programming mode 16
- Setting up
 - Setting up the machine 10
- Switching off 15
- Switching on 15
- Symbol
 - Cleaning 9
 - Coffee 9
 - Coffee Grounds Container 9
 - Coffee strength 9
 - Descaling 9
 - Espresso 9
 - Filter 9
 - Ground Coffee 9
 - Ristretto 9
 - Water Tank 9
- Symbol description 3
- Symbol display 9
 - Messages 21

T

- Technical data 23
- Tel 26
- Transport 23
- Troubleshooting 22

U

- Use, First-time 10

V

- Ventilation slots 8

W

- Water hardness
 - Determining the water hardness 12
 - Setting the water hardness 16
- Water tank 8
 - Descaling 20
 - Filling 12
- website 10

11 JURA contact details / Legal information

11 JURA contact details / Legal information

Headquarters

JURA Elektroapparate AG
Kaffeeweltstrasse 10
CH-4626 Niederbuchsiten
Switzerland

	USA: JURA Inc.	Canada: FAEMA
Customer Service		
Phone	1-800-220-5701	1-(855)-544-8600
E-Mail	info@us.jura.com	info@juracanada.ca
Opening Hours (EST)	Mon – Thu 9am – 9pm Fri 9am – 8pm Sat 9am – 5pm	
Distributor Address	20 Craig Road Montvale, NJ 07645	115 Matheson Boulevard East Mississauga, Ontario, L4Z 1X8
Phone	001 (201) 767-3999	1-(905)-501-8600
Fax	001 (201) 767-9684	
Internet	www.us.jura.com	www.ca.jura.com

@ You will find additional contact details for your country at **www.jura.com**.

Technical changes

We reserve the right to make technical changes. The diagrams used in these instructions for use are for illustration purposes only and do not represent the original colors of the machine. Some details of your ENA may vary.

Feedback

Your opinion is important to us! Use the contact link at www.jura.com.

Copyright

The instructions for use contain information which is protected by copyright. It is not permitted to photocopy these instructions for use or translate them into another language without the prior written consent of JURA Elektroapparate AG.